

interact

Design

Architecture PRF/PRA

Version v2.7

18 March 2025

Contents

1. Design an indoor parking project	1
1.1. Plan the lights and Wireless Gateways	1
1.2. Guidelines for external battery powered motion sensor	13
1.3. System configuration	19
2. Design an outdoor parking project	20
2.1. Typical applications	20
2.2. Design	21
2.3. System configuration	23
2.4. Light behavior	23
3. Design daylight dependant regulation (DDR)	25
3.1. Introduction	25
3.2. Terms and definitions	25
3.3. Why and when to use DDR	25
4. Design a trunking project	28
5. Types of DALI Luminaires	29
5.1. DALI Version 1	29
5.2. DALI version 2	29
5.3. DALI 2 + D4i	29
5.4. SR Drivers	30
5.5. Architecture options	30
5.6. Dali Extender (Recommended Choice if available)	30
5.7. SR Bridge DALI (Recommended choice only when DALI extender is not possible)	31
5.8. SR Bridge 0-10V	32
5.9. SR drivers or D4i drivers directly connected to the SR sensor or antenna	33
5.10. Recommendation table for trunking applications	35

1. Design an indoor parking project

This topic is intended to support the specification and design of an indoor parking project with PRF/PRA.

To design an indoor parking project with PRF/PRA, use the following steps:

- Plan the location of the lights and Wireless Gateways (only applicable for Advanced and Enterprise tiers)
- Define the routes of traffic cars and individuals
- Define the lighting groups and/or groups
- Plan the sensor placement for each group and/or group

1.1. Plan the lights and Wireless Gateways

Luminaires and sensors must be placed at the correct position, to enable the communication with other luminaires. Use the following guidelines when planning the amount of lights and Wireless Gateways:

Distance between luminaires

- The maximum distance in a corridor (D1) is 5 m (16.4 ft).
The maximum distance to the next luminaire (D2) is 10 m (32.8 ft), offering an extra communication possibility.

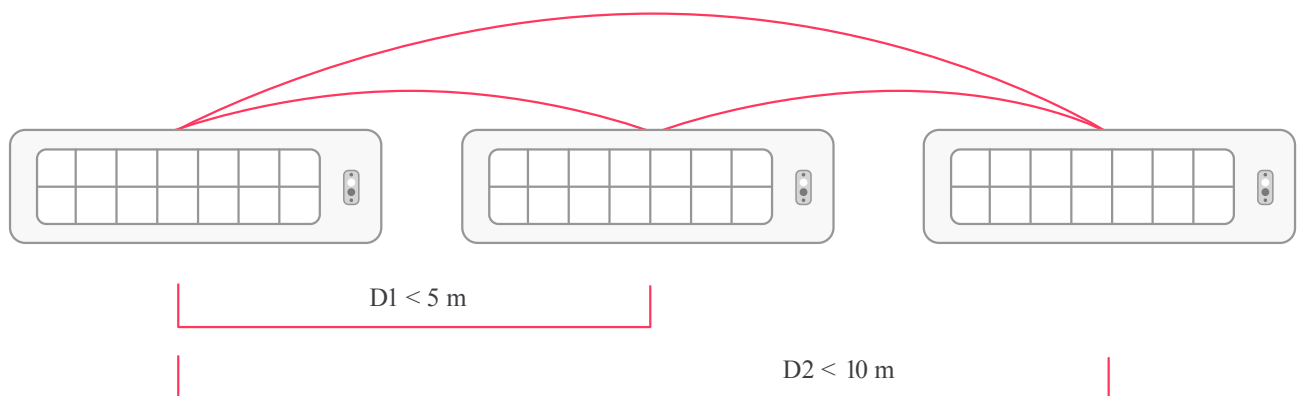

- The maximum between luminaires in an open plan is 10 m (32.8 ft)

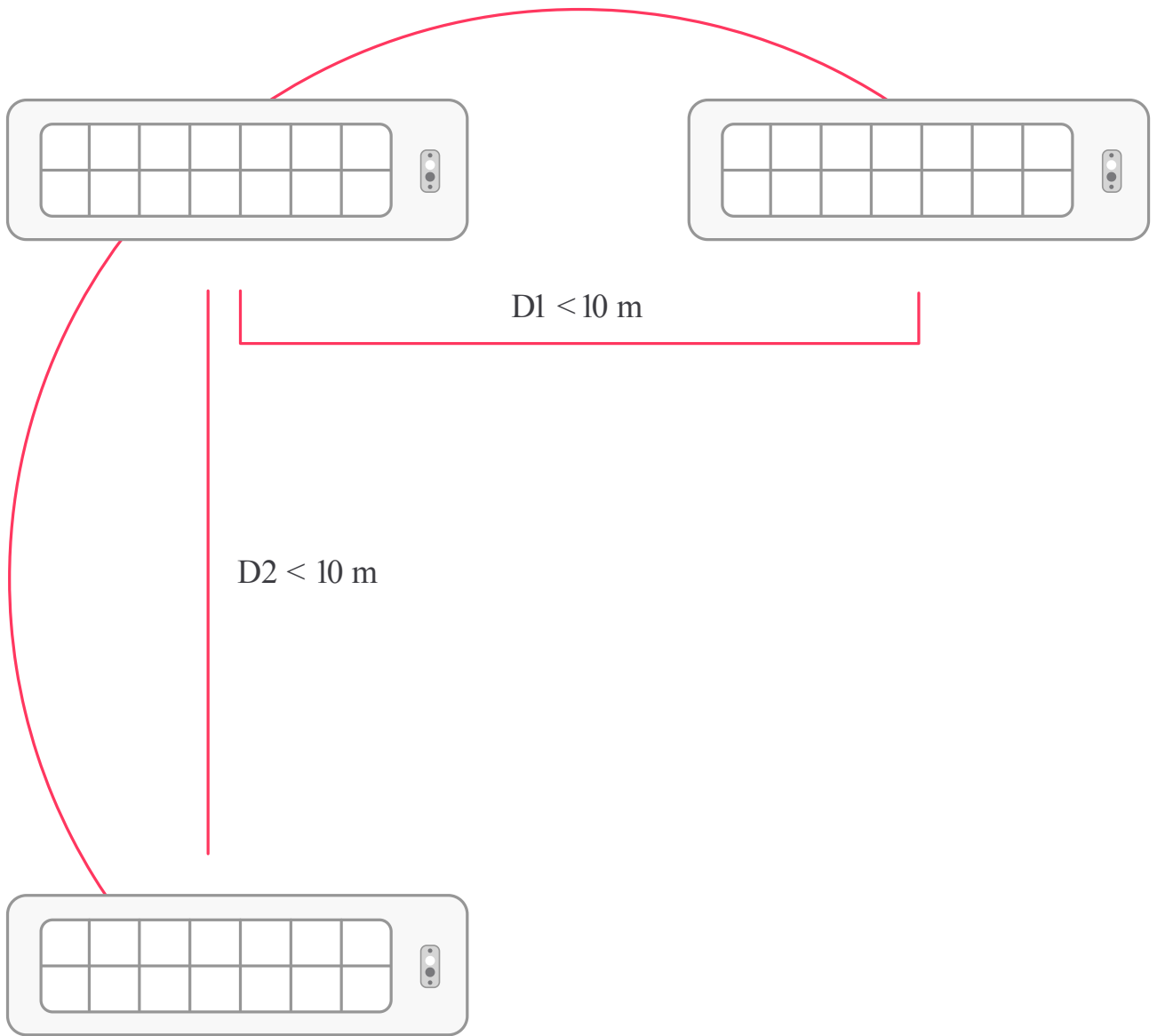

Distance to the wall

The minimum distance of a luminaire from the wall is 0.3 m (0.98 ft)

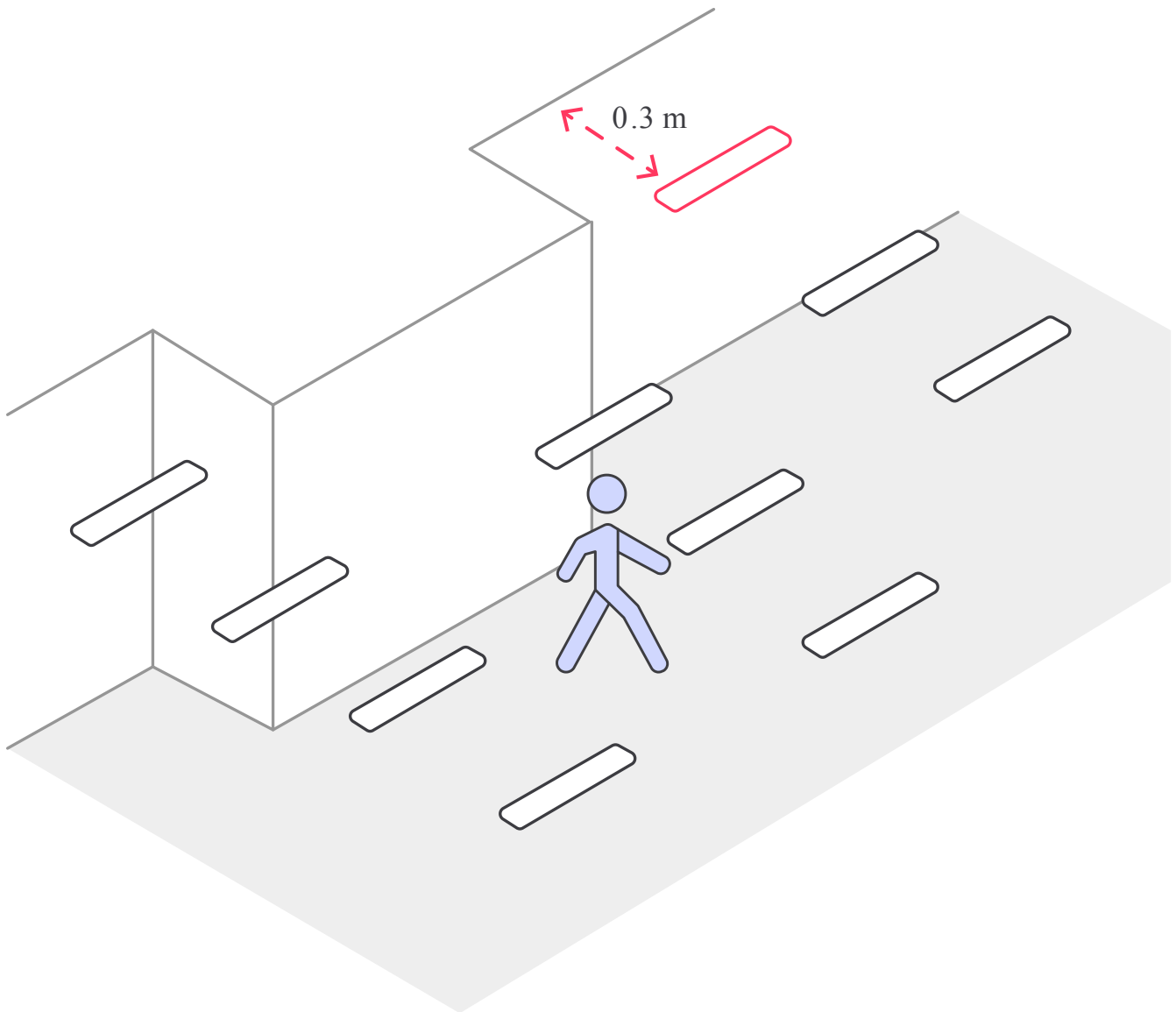

1.1.1. Blocking objects

The following recommendations are made regarding blocking objects:

Uneven ceilings

If the blocking object is between two groups and there is a different communication path to the Wireless Gateway(s), then the luminaires can be installed.

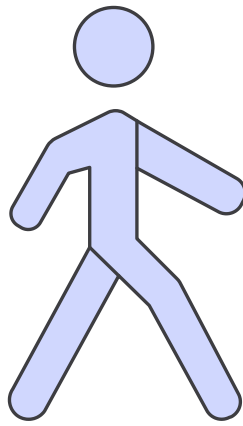
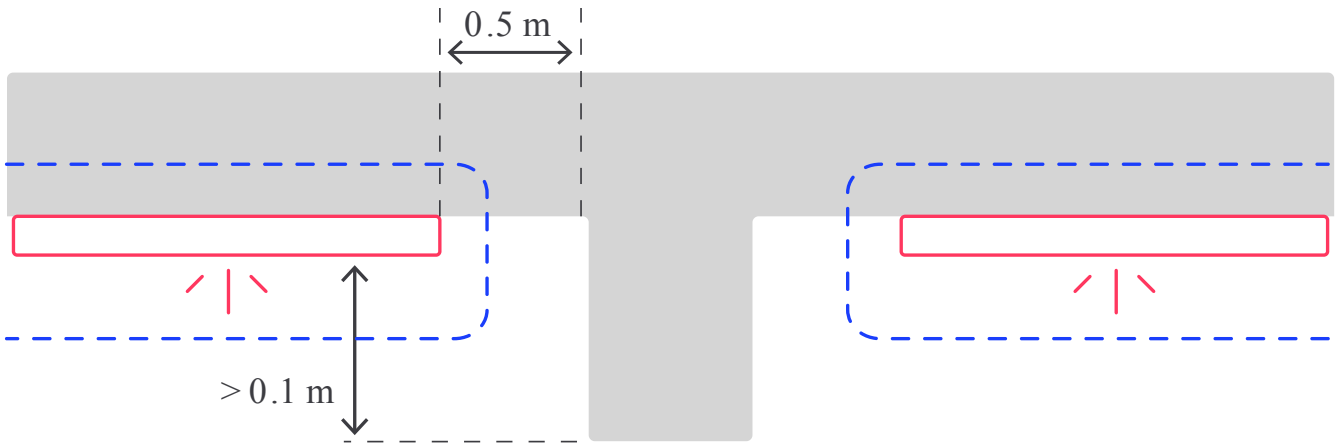

Warning

Do not install the luminaires close to concrete or metal constructions

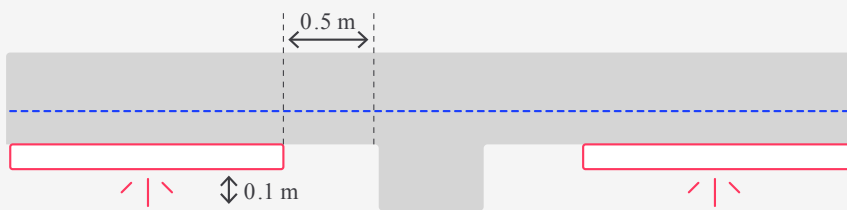

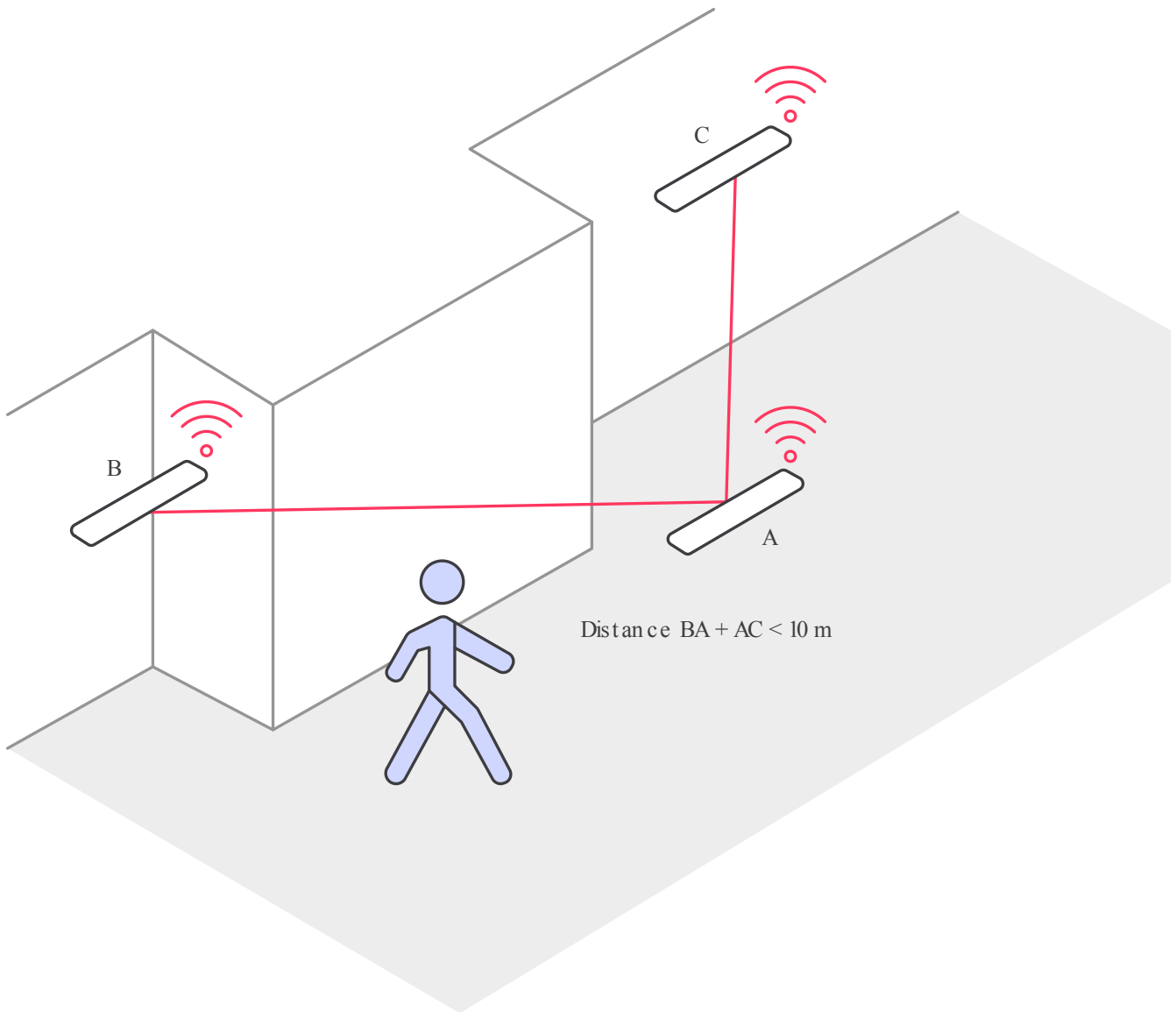

Concrete construction wall

Lights B and C can communicate with each other if the distance between B - A and C - A is less than 10 m (32.8 ft) and there is no blockage present.

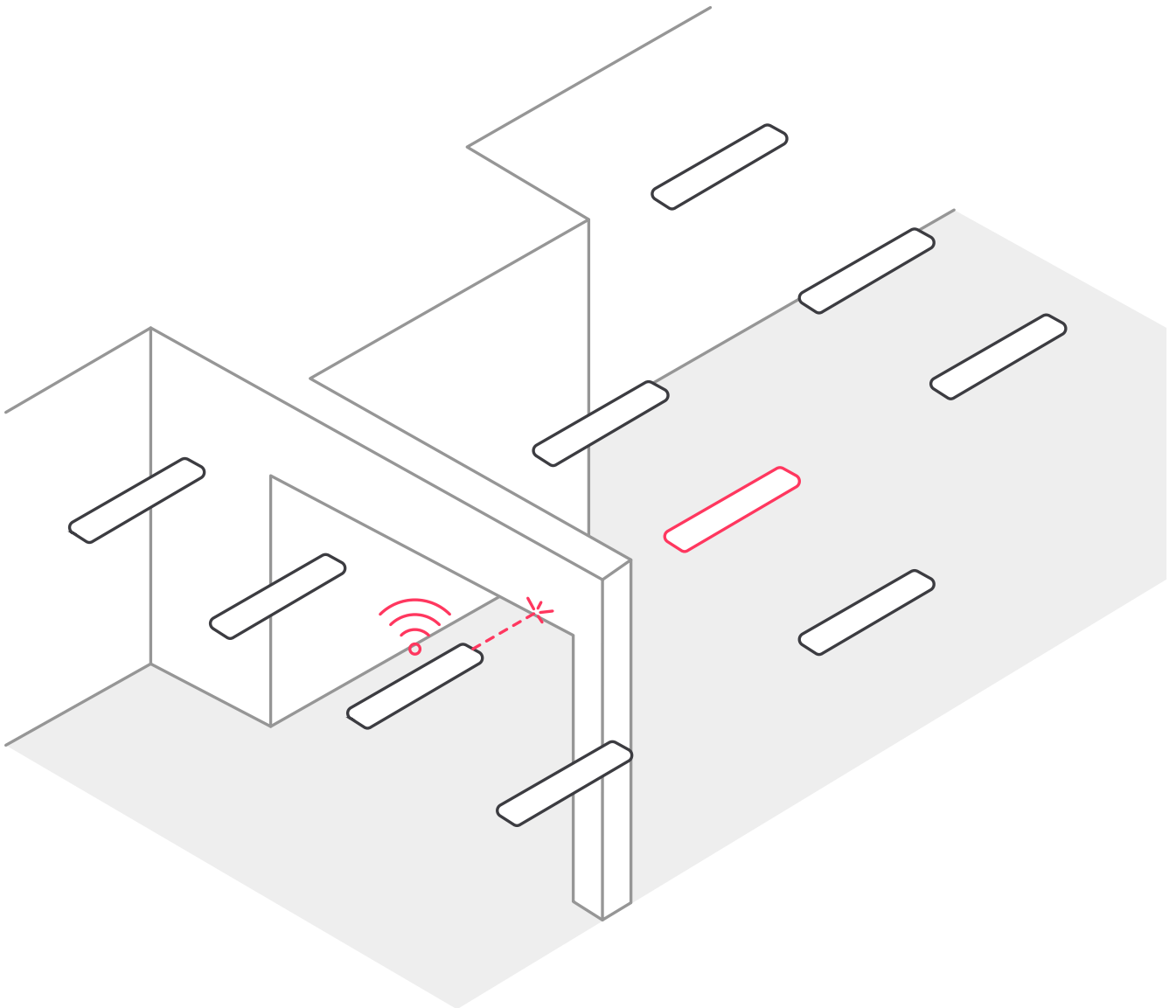

Concrete construction ceiling

A concrete beam can block the communication of the luminaire.

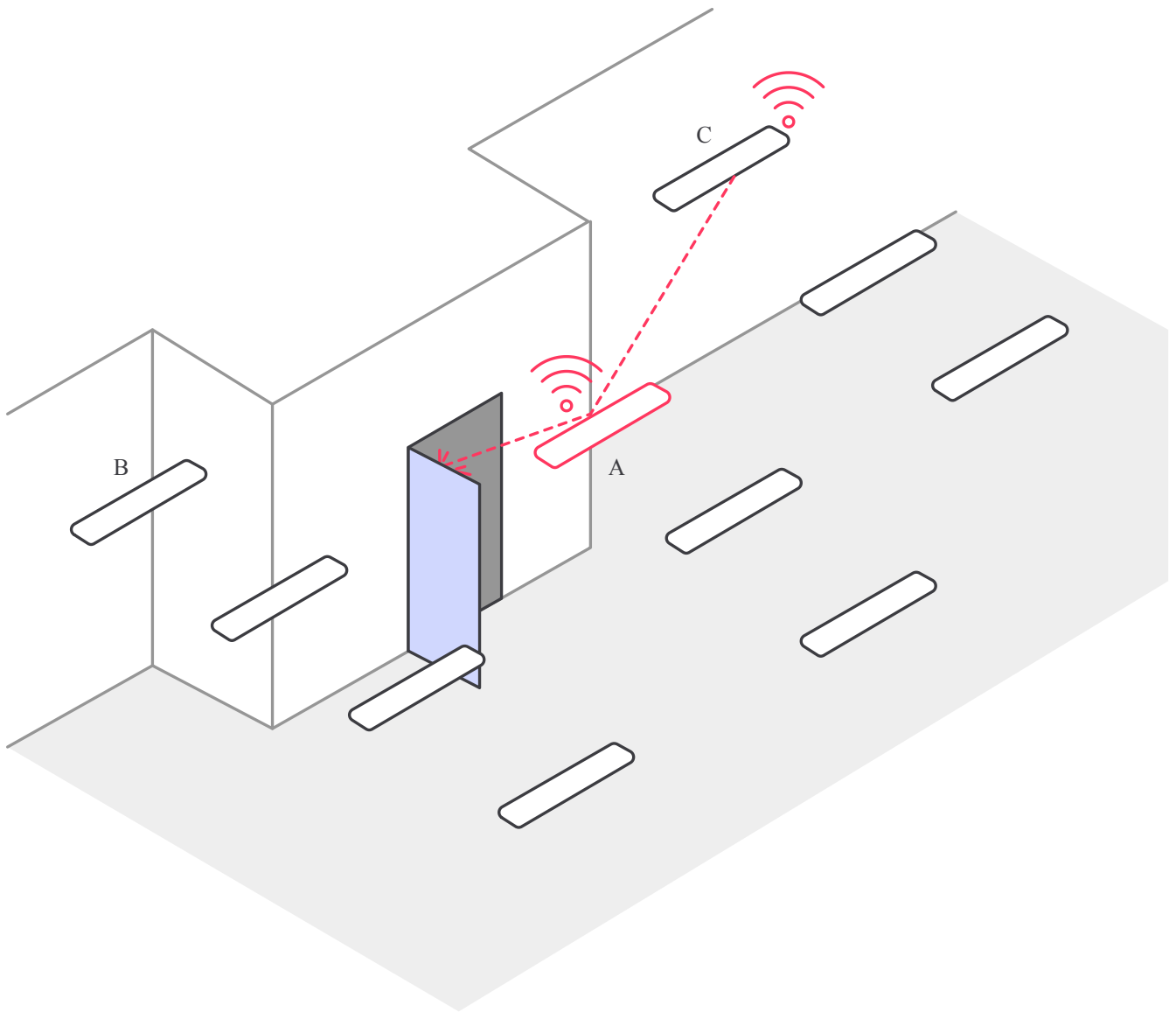

Metal door

A metal door can block the communication of the luminaire.

1.1.2. Map the traffic

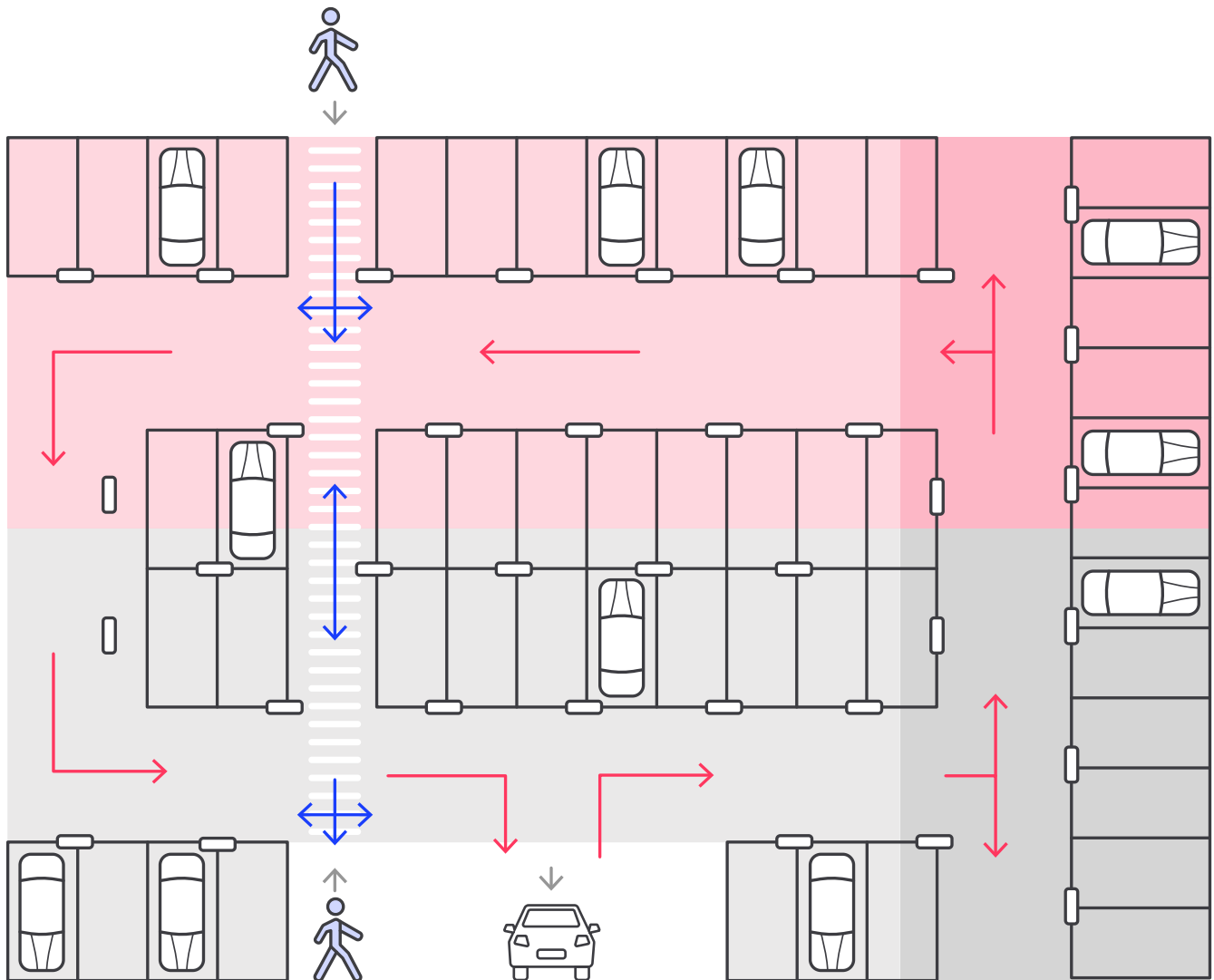

For people walking:

- Start by mapping the formal routes people use
- include alternative routes that are frequently used

For cars:

- Start by mapping the formal routes cars use

1.1.3. Define the lighting groups

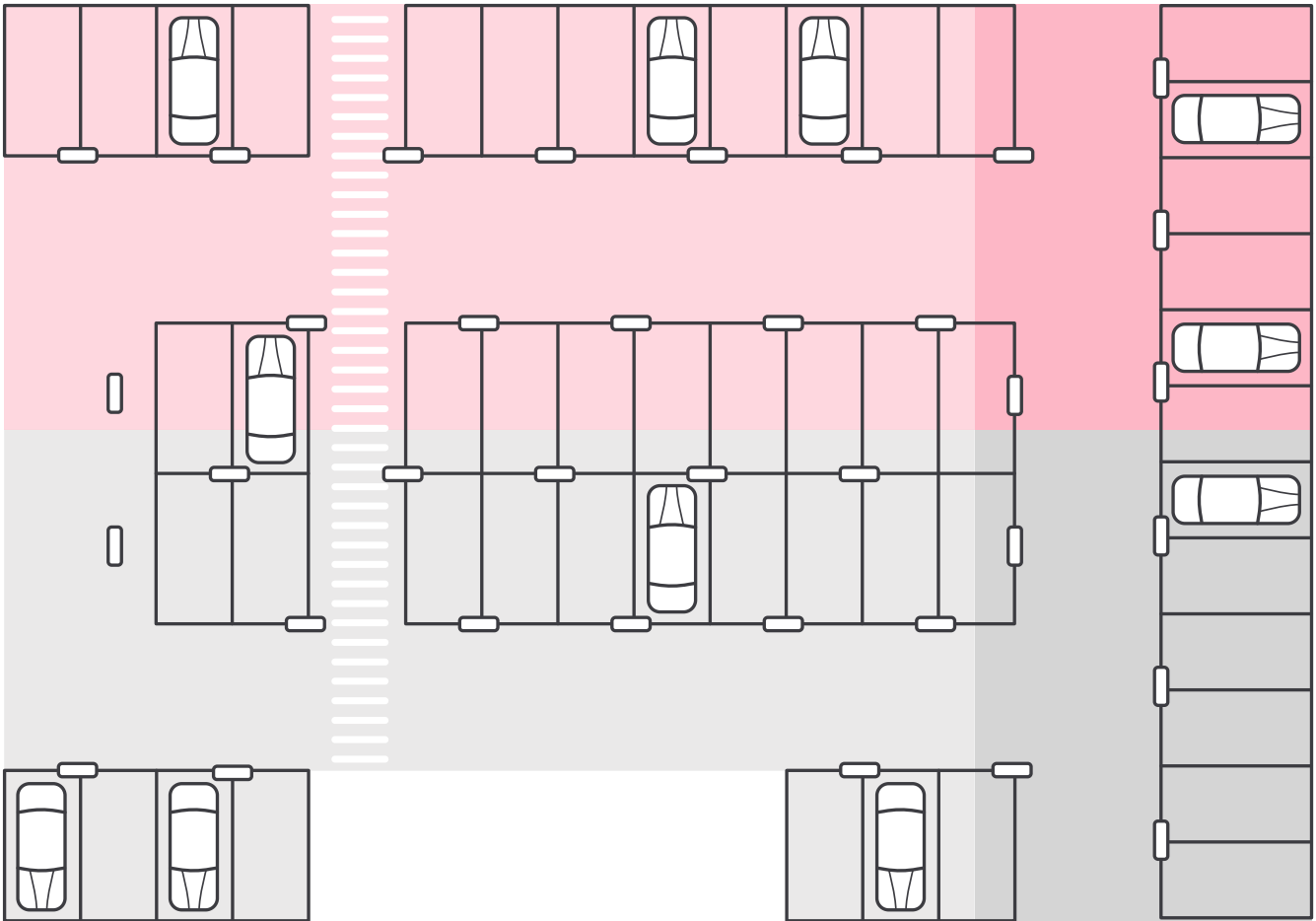

- At the entry of a lighting group sufficiently illuminate all directions (> 10 m).
- Lighting groups follow the official routes in the garage, priority on cars.
- Lighting groups follow logical interior shapes, such as isles, walls, etc.
- group length can be between 20 m (65.6 ft) and 40 m (131 ft) length.
- Lighting group width should include the aisle and bordering parking spaces.

1.1.4. Define the sensor plan for each group

Project the routings on the groups. For each group identify the points of entry for cars and people.

There are different spaces on a parking garage depending on the intended use:

- routing corridors for cars
- parking spots
- routing of people including entrance and exit routes

Smaller groups can provide higher energy savings, while larger groups can provide the conform of light.

Determine the group size based on the environmental conditions and customer preference.

Place battery-powered motion sensors

Place a sensor at each point of entry for people:

- when entering the car park at the edge of the group
- the detection group should overlap the adjacent group by 1-3 m

Place a sensor at each point of entry for cars:

- the detection group should overlap the adjacent group by 2-5 m

Optimizing sensors for cars

In case cars approach an group from more than one direction, different strategies can be applied:

1. Place a sensor right at the entrance of the lighting group

- late response to presence
- low coverage

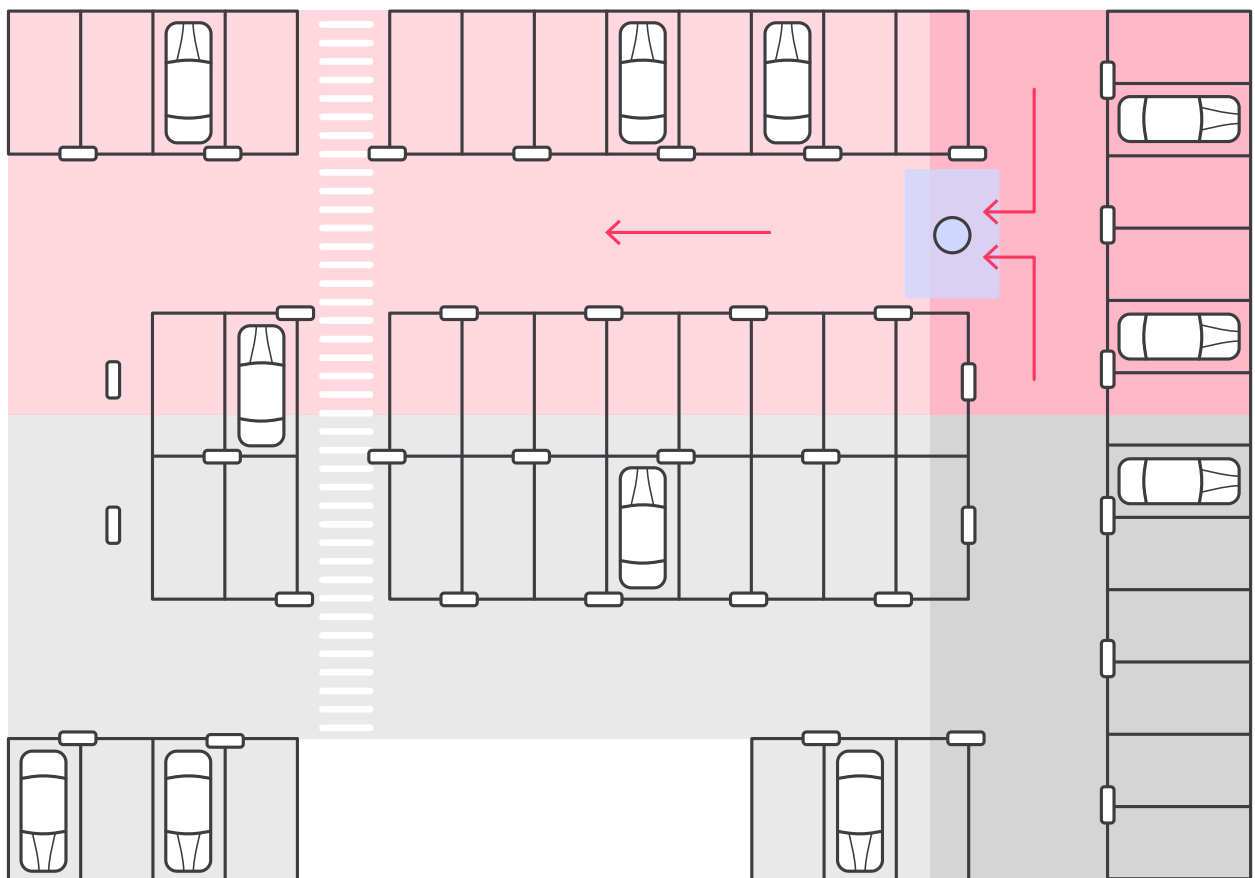

2. Place sensors at each route

- in time response

- more costly
- good coverage

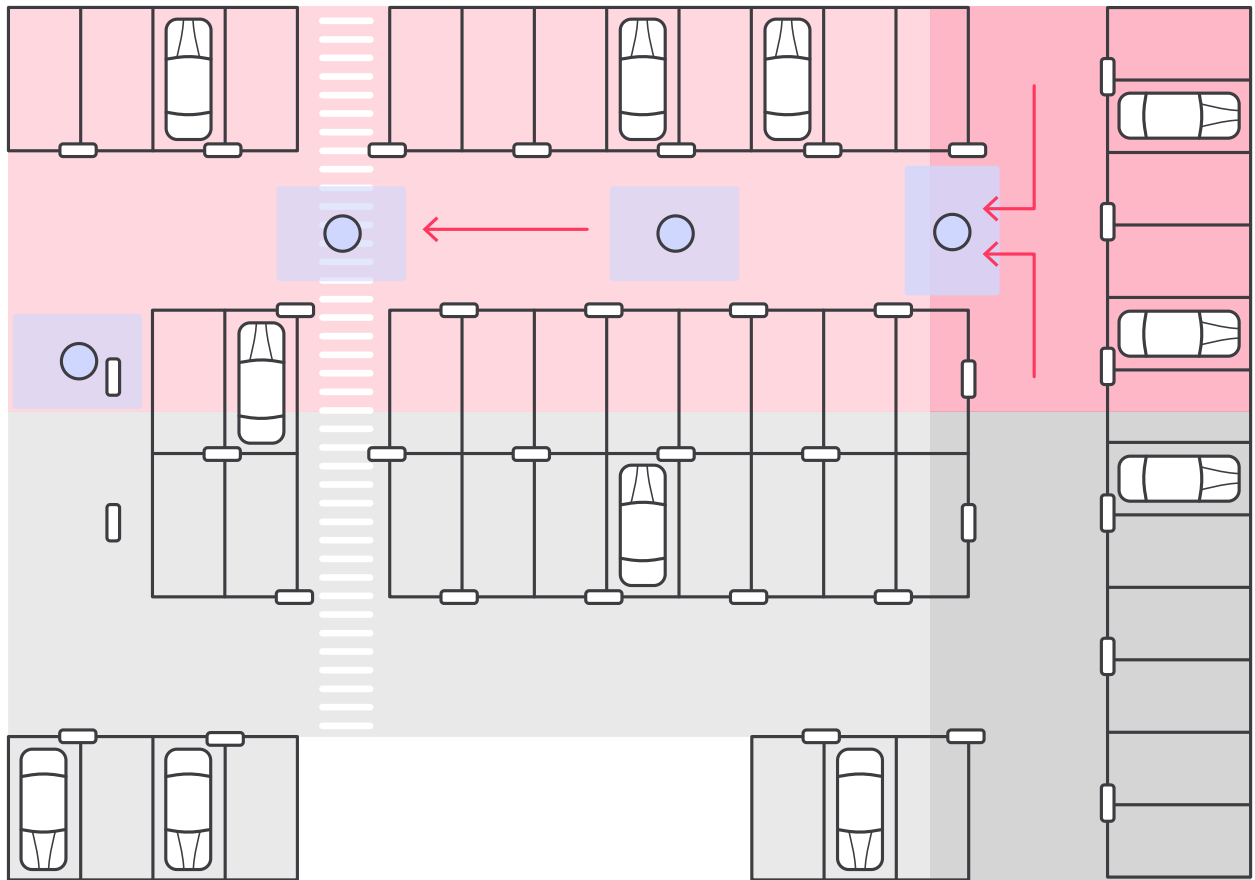

Optimizing sensors for people

Place sensors above each route as shown below:

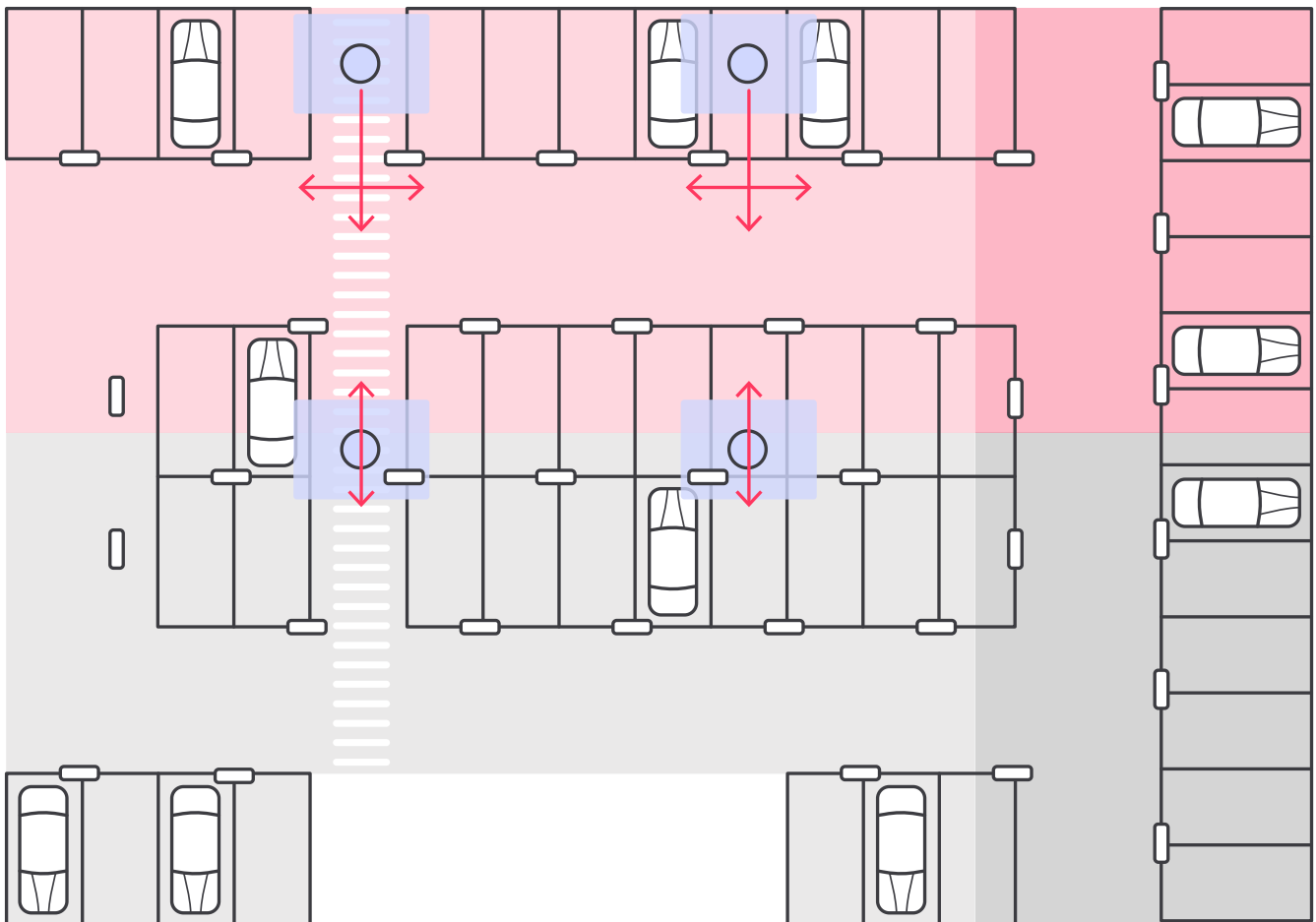

Note



In case an group can only be entered from one direction, the light can dim before people have left the group. This can be prevented by placing supporting sensors.

1.1.5. Daylight harvesting

When daylight harvesting is used, place the sensors as instructed in the specification sheet.

Note



Only one daylight harvesting ZGP sensor can be used for per group. Choose the best position for this sensor which represents a good average for the full group.

Field of view daylight

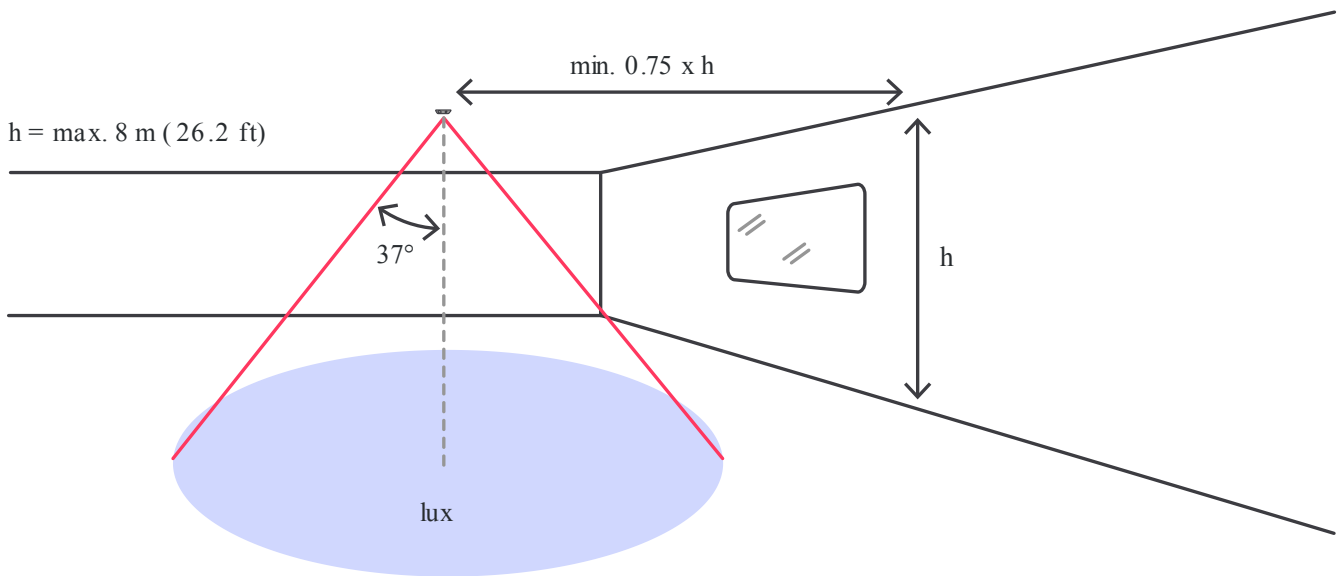

1.2. Guidelines for external battery powered motion sensor

1.2.1. Secure contact between sensors and luminaires

The following practices must be applied to secure contact between sensors and luminaires:

- Every sensor must be capable of establishing a connection with at least two luminaires
- Every luminaire must be capable of establishing a connection with at least two other luminaires

By implementing the above practices, the sensor can relay data to an alternative luminaire when it is unable to contact one.



Note

Depending on the size and nature of present obstacles, each location must be individually verified.

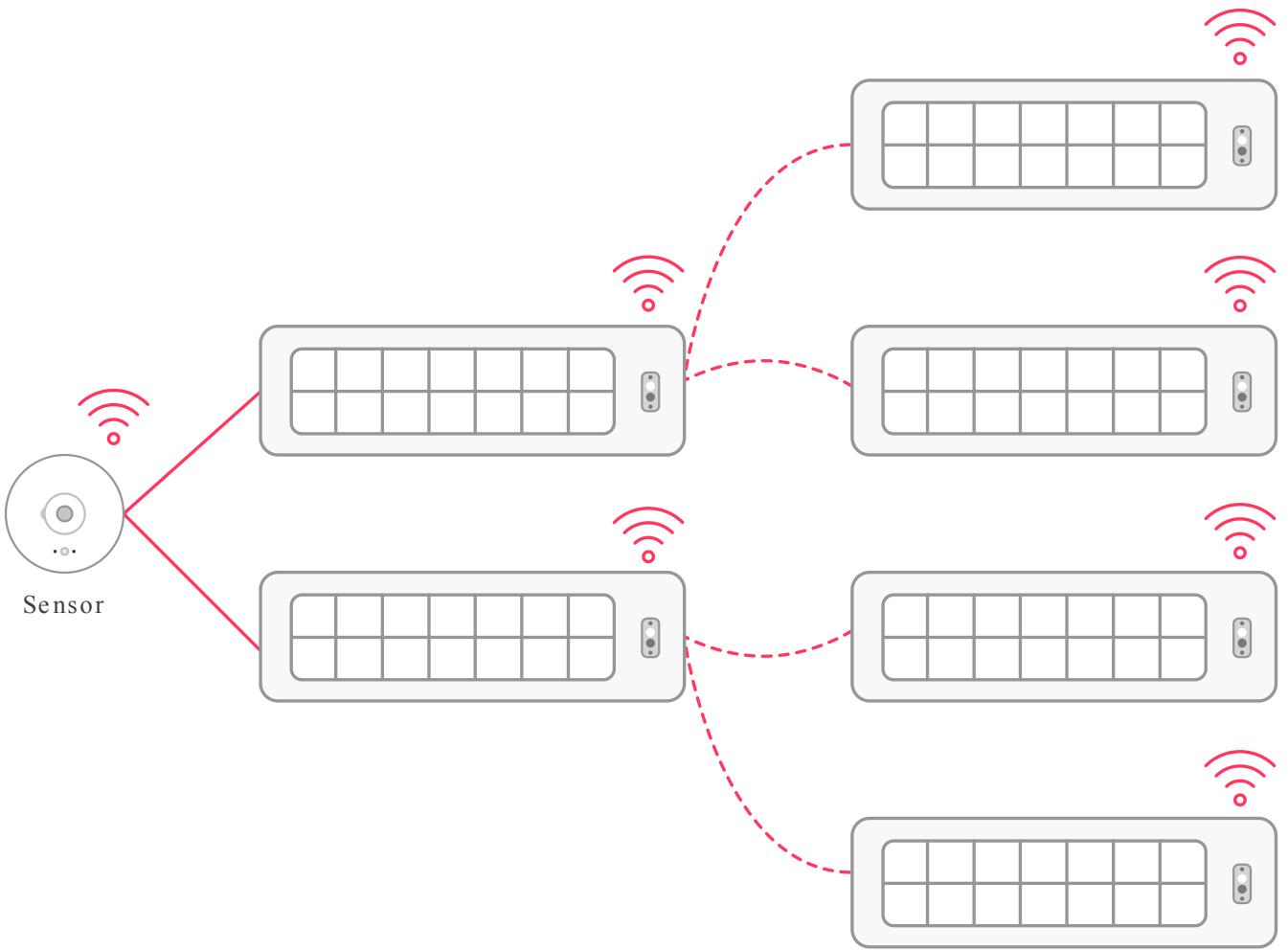

1.2.2. Position motion sensors

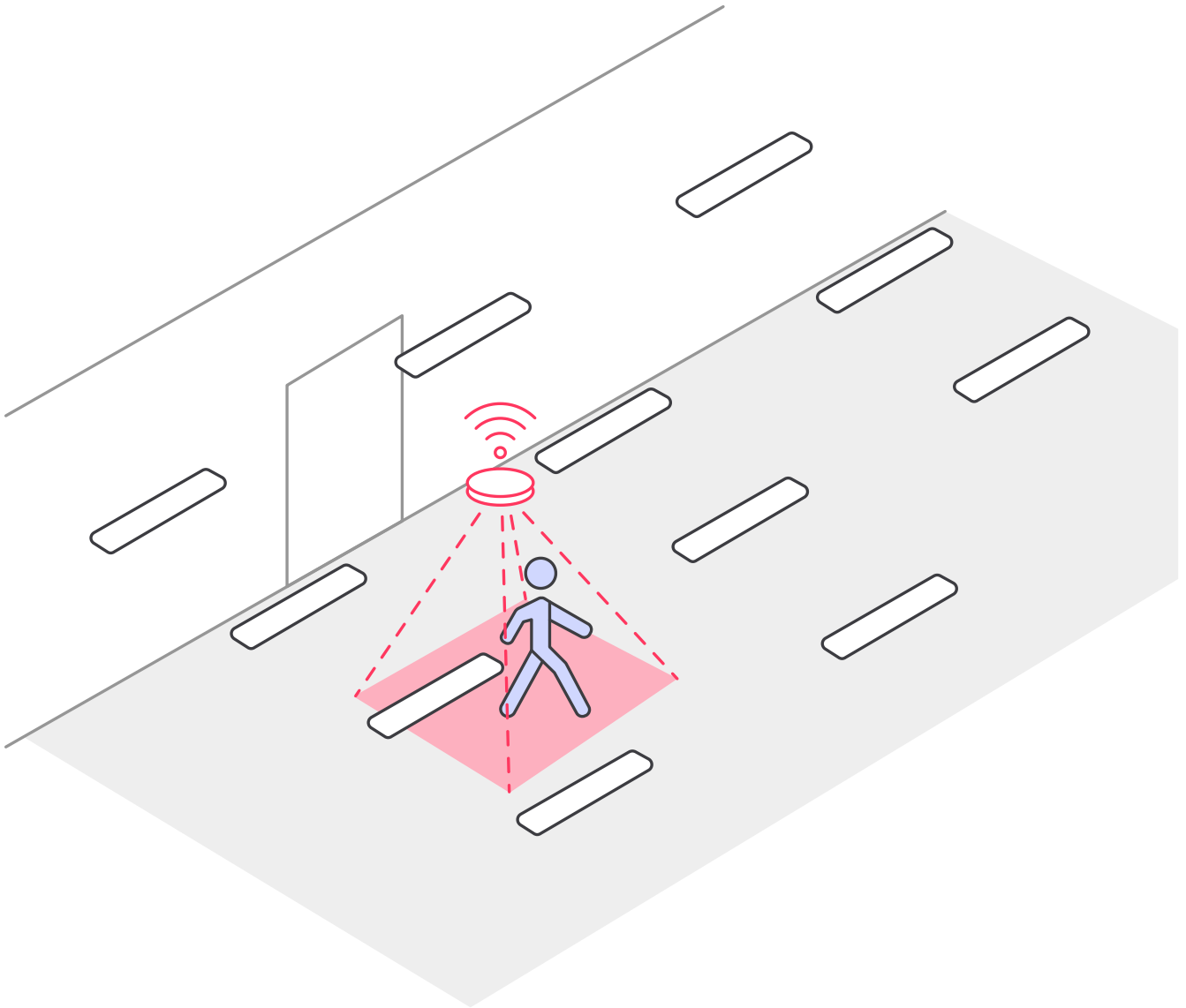

Add a ceiling sensor at every entrance/exit route, both for people and cars.

Field- of-V view

Field of view motion

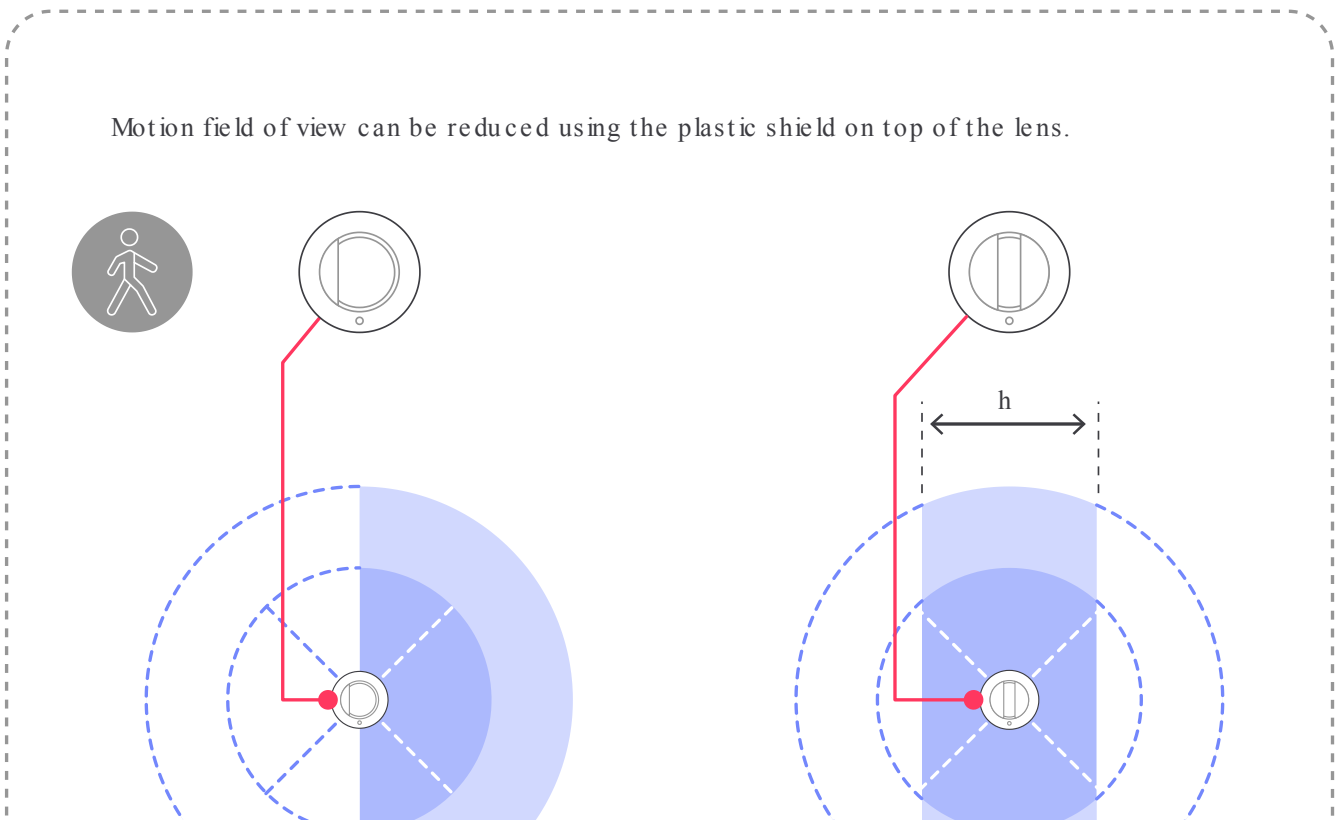
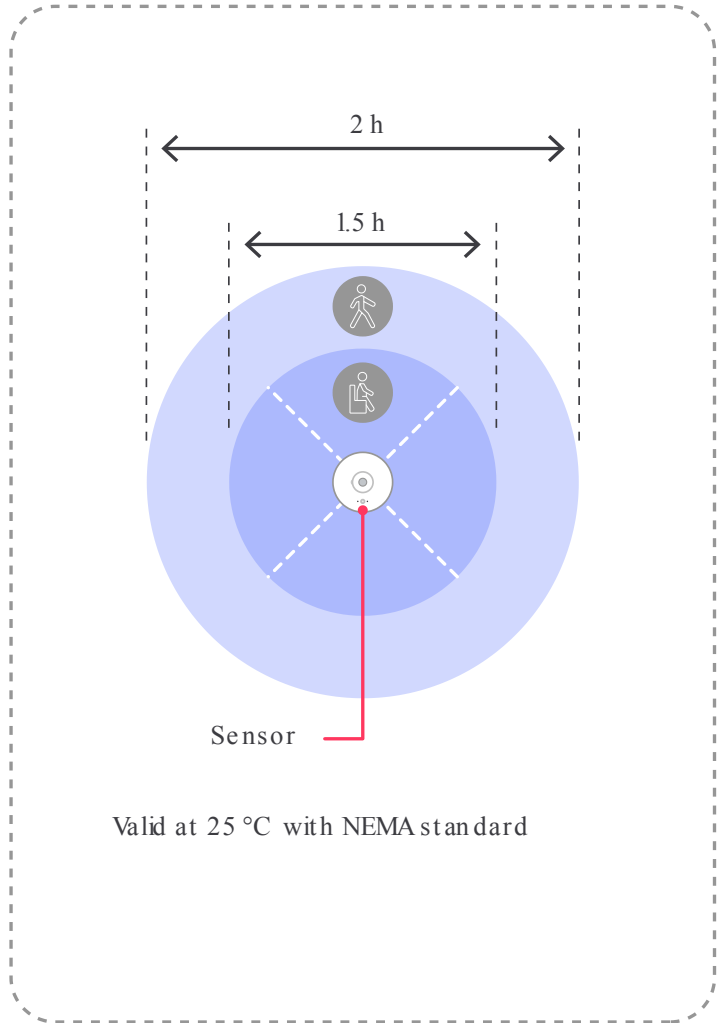
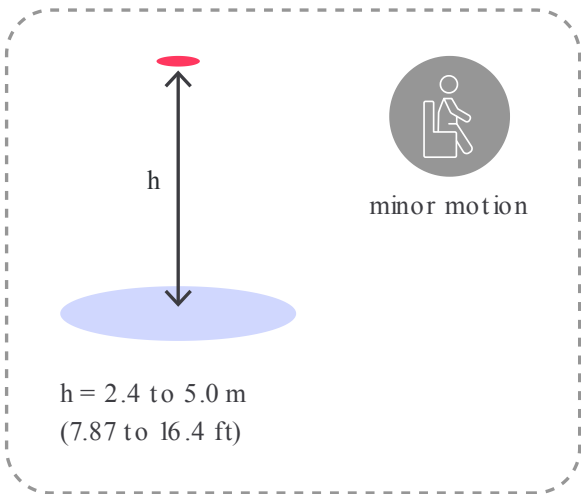
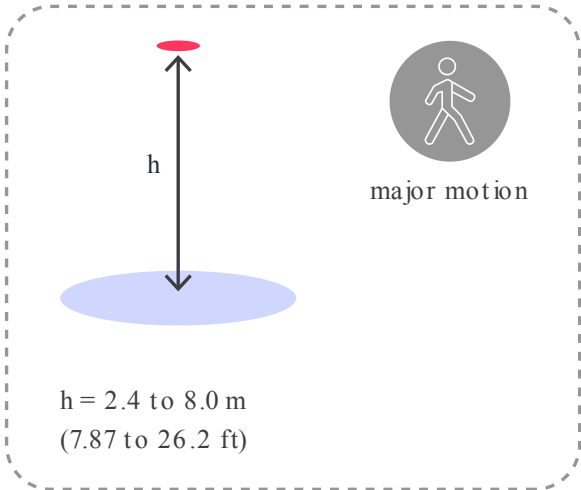

Sensor detection group

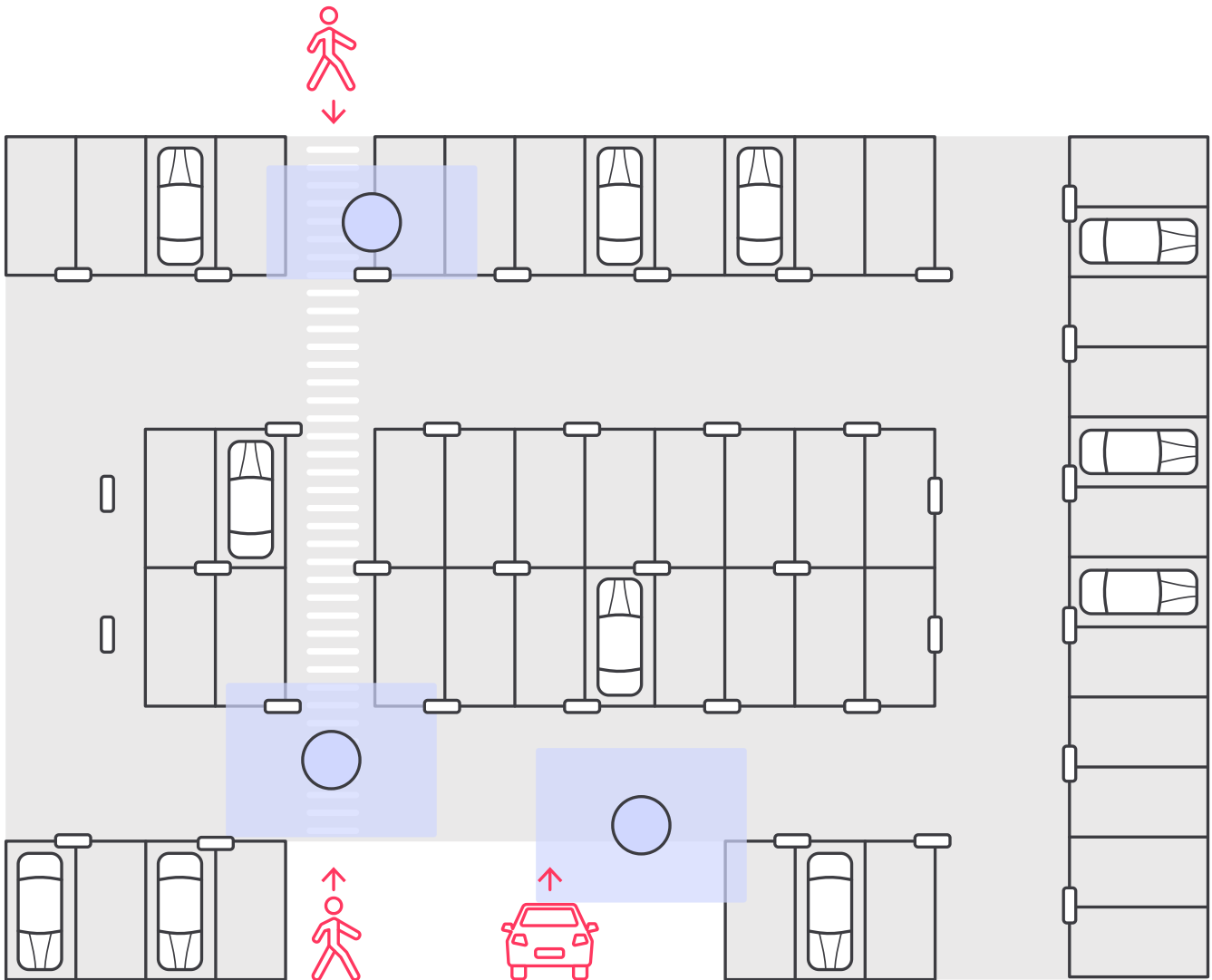

For example, ceiling sensors are installed at the entrance of the parking lot. The luminaires connected to it, switch on to task level as soon as the sensor detects a car or pedestrian entering the field of view. Now the driver or pedestrian has a clear view ahead.

1.2.3. General rules for external battery-powered sensors



Warning

ZGP battery-powered sensors do not report the battery level or when it is depleted. It is only possible to check if the sensor fails by verifying the LED indicators on the device.



Important

Replace the ZGP sensor's battery before the end of life.

- Place the sensors at the entrances of the parking lot and groups, based on the defined routes for cars and pedestrians.

- Place supporting sensors only when needed, such as large zones with only one entry or exit point
- It is not required to cover the complete group with sensors
- Take into account that cars and objects can block the sensor's field of view
- Install the sensors away from sources of heat

1.3. System configuration

1.3.1. Light behavior parameters for parking projects

Hold Time

The hold time configuration is a balance between visual comfort and energy savings, when increasing the hold time, it is less possible an group will turn off while there is someone still on the space, but this will result in the lights being turned On for longer periods of time, this balance can also be affected by the density of sensors designed, with a higher density of sensors a lower hold time can be used. For ZGP sensors the minimum supported hold time is 5 minutes, this is good enough for most situations, but when designing for a low density of sensors make sure the hold time is increased to 10 or 15 minutes.

Vacant level

For special situations where visual comfort is important, vacant level can be configured to a low dim level, for example 20%, this will prevent the lights turning off even when there is no presence, it can be combined with schedules to set it back to 0% when off working hours.

Others

Parameters like task level is usually set to 100% unless a lower light level is required than the one installed, the background level and prolong time are optional, but usually not commonly used for parking applications.

2. Design an outdoor parking project

This guide is intended to support the specification and design of an outdoor parking project.



An outdoor parking application has a few important extra requirements compared to an indoor project. These requirements have an impact on the devices and luminaires used on it, including:

1. Environmental protection against rain, dust and temperature.
2. Distances between luminaires and mounting height are much longer compared to an indoor environment.

The outdoor parking application for PRF/PRA is enabled by using the Philips outdoor parking sensor (LCN4120/LCN4150).

2.1. Typical applications

- Building perimeter parking.
- Building perimeter areas.

Top-deck parking lots.

- Dedicated parking lots (Only when the gateway can be protected from the environment, by an IP rated plastic box or an indoor building close by).

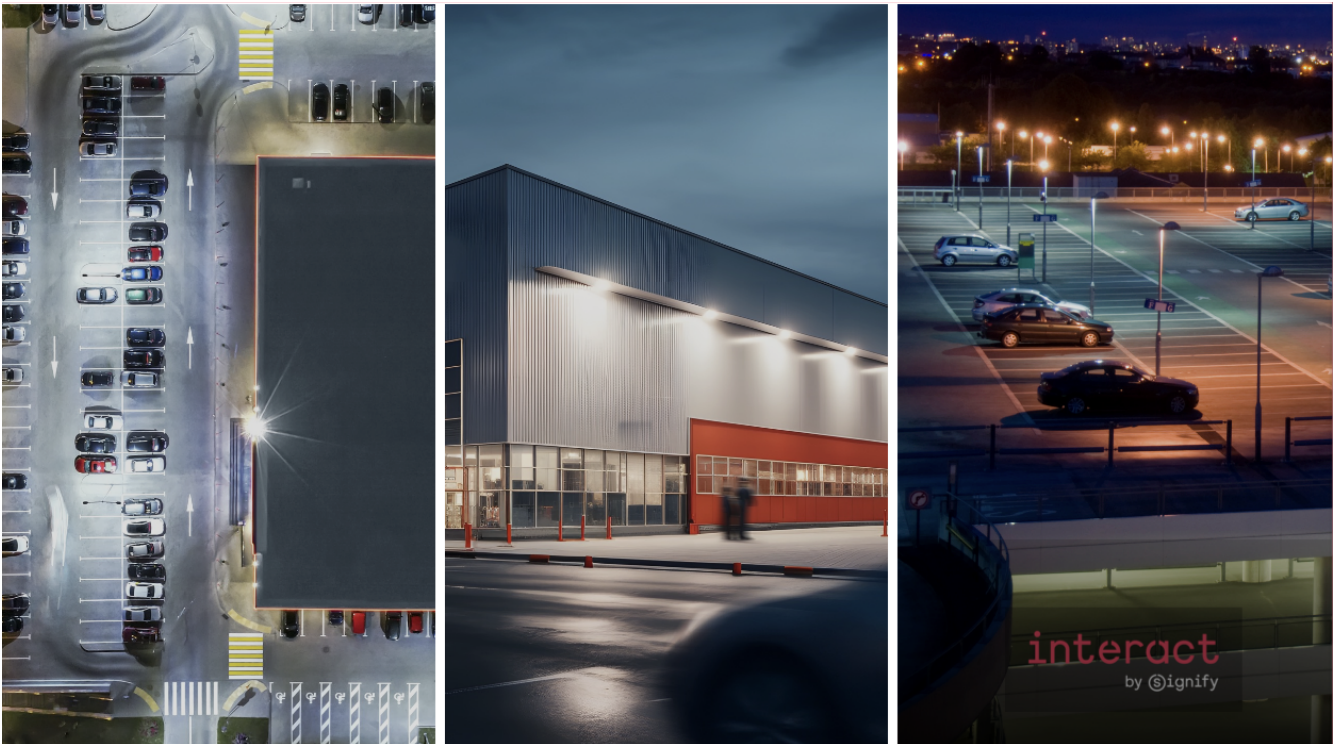

2.2. Design

To design an outdoor parking project, use the following steps:

- Plan the location of the lights and Wireless Gateways
- Define the routes of traffic cars and individuals
- Define the lighting groups
- Define the light behavior for each area

2.2.1. Plan the lights and Wireless Gateways

Luminaires and sensors must be placed at the correct position to guarantee a robust performance of the ZigBee network.

Distance between luminaires and Wireless Gateway

- The maximum distance between luminaires with an integrated parking sensor is 49m(160ft)
- The maximum distance of the first luminaire from the parking space to the Gateway if located inside the building is 10m. Consider the distance from the gateway to the wall and from the wall to the first luminaire shall not add up to more than 10m. In case the gateway can be installed in an exterior plastic

box to protect it from the environment, the distance can be extended to 20m. Always make sure to have two or more luminaires inside the gateway range to prevent losing connection to the mesh network.

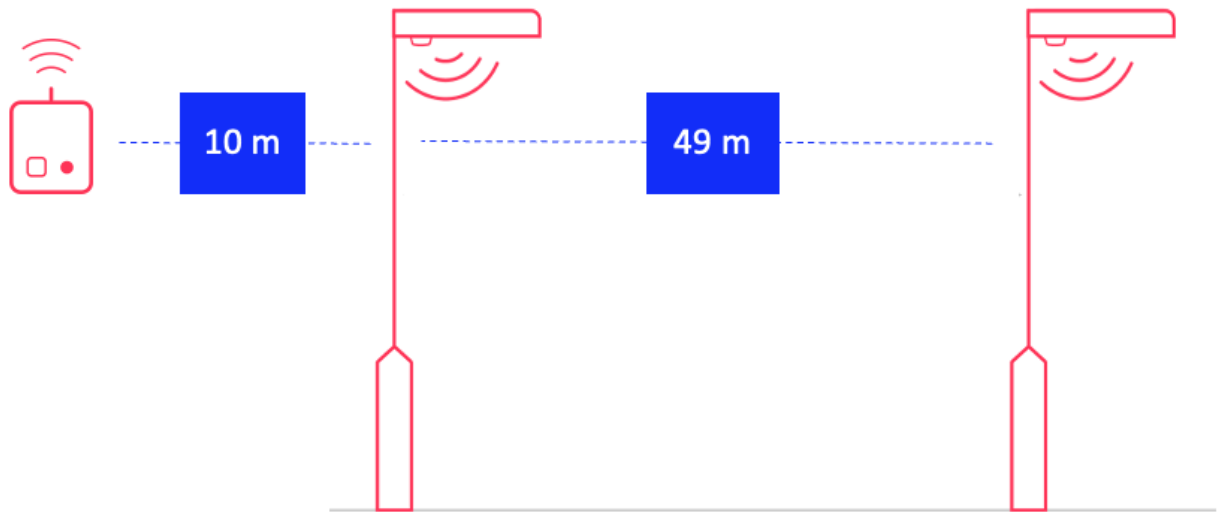

2.2.2. Blocking objects

The following recommendations are made regarding blocking objects:

1. 49m(160ft) is only supported when there is a direct line of sight to the neighbor luminaire without any obstructions.
2. Do not install the luminaires close to concrete or metal constructions that can obstruct the signal.
3. Avoid the proximity to trees or branches that can block the direct line of sight. When obstacles are present, reduce the effective range to 20m.

2.2.3. Map the traffic

For people walking:

- Start by mapping the formal routes people use.
- Include alternative routes that are frequently used.

For cars:

- Start by mapping the formal routes cars use.

2.2.4. Define the lighting groups

- At the entry of a lighting group sufficiently illuminate all directions.
- Lighting groups should group luminaires that follow a specific route in the parking space.
- Grouping many luminaires into a single Lighting groups can improve uniformity and user experience at the cost of less energy savings. Find the right balance depending on the customer needs to maximize both comfort and energy savings.

2.2.5. Check sensor coverage

Select the lowbay or highbay sensor depending on the mounting height and confirm that the coverage of the sensors is enough.

In case the sensor coverage is not enough, consider adding more luminaires to the blind spots to guarantee the correct coverage. If adding more luminaires is not an option, then the system can mitigate lack of coverage by extending sensor hold times or by adding a vacant level higher than 0%.

2.3. System configuration

2.3.1. Daylight dependent regulation

Normal daylight dependent regulation is not used in outdoor parking applications, as the sun light provides enough light to keep the luminaires off during the day.

2.3.2. Outdoor parking daylight override

Outdoor parking daylight override (dim to off option) enables the luminaires to automatically switch On and Off during the day and night cycle based on light levels.

Important



When using Outdoor parking daylight override, background level and vacant level must be kept to 0%. If a vacant level different from 0% is required for user comfort, then schedules must be used.

2.4. Light behavior

Note



The recommended template to be used is Auto On Auto Off with DDR in case Outdoor parking daylight override is used. If schedules are used, then Auto On Auto Off can be used.

2.4.1. Light behavior parameters for parking projects

Hold Time

The hold time configuration is a balance between visual comfort and energy savings. When the hold time is increased, it is less possible a group will turn off while there is someone driving or walking on the space. But this will result in the lights being turned On for longer periods of time, saving less energy. The recommended hold time for most parking applications is five minutes, while for some special cases a lower hold time might be adequate to maximize energy savings.

Vacant level

Vacant level should be set to 0% when used in combination with outdoor parking daylight override.

Others

Parameters like task level or high-end trim are usually set to 100%, unless a lower light level is required than the one installed. The background level and 'Prolong' time are optional, but not commonly used for parking applications.

3. Design daylight dependant regulation (DDR)

The purpose of this document is to explain how to design projects using Daylight Dependant Regulation (DDR) and achieve the best possible energy savings, while maintaining the desired light levels.

3.1. Introduction

Daylight Dependant Regulation (DDR) refers to the capability of a sensor to measure light levels and maintain a desired calibrated lux level (set point) by dimming up or down a single or a set of luminaires. In other words, when natural light starts entering the building, the luminaires will dim down to save energy, and when it gets dark, the lights will automatically dim to maintain the desired light level.

3.2. Terms and definitions

- Set point: Refers to the value in Lux levels, which the sensor is calibrated to achieve, this set point is then exposed on the system as a percentage. The calibrated level is 100%, and it can be dynamically adjusted by using the circadian programs feature.
- Daylight calibration: Refers to the process to measure the target lux level to be used as a set point.
- Closed loop DDR: Refers to the case where the sensor measures both the luminaire brightness and the natural light, this means if the sensor is installed on the ceiling it will be facing down to measure all reflections from both artificial and natural light. Any increase or decrease on the light levels provided by the luminaire will also impact the sensor measurement, meaning the control loop is closed (any change done by the control system is also received as feedback).
- Open loop DDR(currently not supported by the system): Refers to the case where the sensor measures only natural light, this means if the sensor is installed on the ceiling it will be facing up or directly to a source of natural light, then based on this measurements the system can set different light levels, any increase or decrease on the light levels provided by the luminaire will not have any impact on the sensor measurement, meaning the control loop is open (no direct feedback on changes).
- Switch on level: When combining DDR with an occupancy sensor, the "task level" as configured on the template parameters of a lighting area will behave as a switch on level, meaning as soon as occupancy is detected, luminaires will go to task level and then start regulating to the setpoint.

3.3. Why and when to use DDR

DDR is an energy saving feature, it is always desired for any building which can leverage natural light to save energy, however the technology comes with a few limitations to be considered before designing a project to use this feature. DDR might not be the best solution when the following scenarios are present: * Natural light is directly reflected to the sensors on the ceiling, for example, when there are windows close to the ceiling only and or surfaces that can reflect sun light directly to the sensors, in these cases the DDR behavior will decrease the dim level of the luminaires to resulting in lower light levels than required. * Sensors cannot be positioned according to the design guidelines, avoiding close proximity to direct sun light reflections. * Non-dimmable luminaires.

Common applications for DDR:

Office, schools or any buildings with a lot of natural light.

- Industry or warehouse buildings.
- Retail stores.
- Any indoor space with natural light or higher lux levels than required for the space to design.

How does DDR works?

DDR is enabled by using a template with the DDR letters at the end, for example "AUTO ON AUTO OFF with DDR". Depending on the settings, DDR can be enabled by an occupancy sensor, a local switch, BACnet, the UI or a personal control app.

When DDR is enabled, the sensor will measure lux levels, which will come from the reflection on the surfaces below the sensor of the light provided by the luminaires together with the light provided by natural sources. These measurements will then be compared to the set point (calibrated value). If the set point is lower, then the sensor will slightly increase the dim level of the luminaires. If it is higher, then the sensor will decrease it, this cycle happens multiple times until the measured level falls between $\pm 5\%$ of the target setpoint. The 5% is used to stabilize the behavior and to prevent continuous system corrections, which will keep on happening forever and is also known as "system hysteresis". This 5% means that if the lights are calibrated to reach 500 Luxes, then the measurement range can be between 475–525 Luxes.

How to calibrate a sensor to use DDR

Calibrating a sensor means setting a reference lux level on the sensor to use it as the target level when using DDR.

Important



The calibration process should always be done at night, to ensure there is no natural light present during the calibration, this will ensure the light levels are properly configured and will achieve the best outcome.

During a calibration process, the luminaires on the complete floor will continuously switch On and Off while each sensor takes measurements, this process will last for about 7 minutes. The sensor will be calibrated with 100% of the luminaires output as a setpoint. In case a lower setpoint is required, the high-end trim parameter can be used to limit the maximum level that the areas will use during the calibration process.

Important



After changing the high-end trim levels for a luminaire or an area, a re-calibration of the sensors must be done to update the set point.

DDR performance

DDR is not an accurate way to measure Lux levels, while it performs well to save energy, due to the nature of the measurement it is not 100% reliable. The reason is that it uses an indirect measurement of light and assumes a proportionality to the level on the floor or desk.

CLO (Constant light output)

Constant light output refers to the capability of a luminaire to maintain the designed light output over time. LEDs will degrade overtime, resulting in less light output, and will need to be replaced when the output cannot reach the desired lux level. A maintenance factor is used on lighting designs, meaning the luminaires will provide more output than required. This will guarantee when the LEDs reach the end of their lifetime, the lux level will not be below the minimum required for the specific application. Note that by dimming down an LED luminaire, the decrease of its light output over a period of time is less than that of when used on full brightness. All documentation on expected lifetime in hours (usually close to 50.000 hours), relates to the maximum degradation when used at full brightness.

CLO can be achieved by two commonly used strategies:

1. Using DDR + High end trim to guarantee the desired lux level, then increasing high end trim gradually to 100%. This will allow the luminaires to increase their output over a period of time to compensate for their normal degradation.
2. Using the driver CLO feature, this option will ensure the maximum output of the luminaire that follows a degradation curve based on use. It means the luminaire will start increasing its maximum output over time, without relying on the system. This option needs to be configured directly into the driver, (Multione tool for SR drivers with this feature) and the system does not have any means to enable/disable this functionality.

DDR maintenance

To keep DDR levels and savings, it is important to re-do the calibration of the sensors over the lifetime of the project at a minimum 1-2 times per year. A calibration should be done in any of the following scenarios: * Building is recently painted. * Mobiliary change (desks, chairs, etc...) * Floor change or deep cleaning * Cleaning of the luminaires * Replacing an old/broken luminaire with a new one. * Any changes which will result in to different light level reflections into the ceiling.

4. Design a trunking project

The purpose of this document is to explain different trunking options and which devices/architectures to choose depending on benefits and limitations. Introduction

Trunking covers any architecture where more than one driver is connected to a single wireless node, for example a sensor SNH210, SNS210, SC1500 or an antenna like the SNS441. Independently from the solution selected, when connecting multiple drivers to a single wireless node, all drivers always switch ON/OFF and dim together, it is not currently supported to address each one independently.

The following devices can be used for trunking applications and are compared against each other with benefits and limitations, also what is the recommended choice:

- DALI extender
- SR Bridge DALI
- SR Bridge 0-10V

5. Types of DALI Luminaires

First it is important to understand what type of DALI driver is in the luminaire, these can be identified by the icon printed on the driver or the datasheet, for the purpose of trunking applications we can have the following 4 varieties:

5.1. DALI Version 1



DALI 1 or commonly known as just DALI refers to an older version of the DALI protocol which only included control gear, it is not possible anymore to certify new products for DALI 1, for the purpose of this guide it is relevant to know that a DALI 1 driver does not provide a standardized way to report energy metering, it also does not provide power over DALI to energize a sensor.

5.2. DALI version 2



DALI-2 brings the promise of significantly improved interoperability and additional functionality compared with current DALI version-1 devices. specifically, part 251, 252 and 253 guarantees that the driver to be compatible with our sensors and devices. DALI 2 drivers enable the possibility to directly read energy consumption, failures and device type (digital service Tag) from standardized memory locations. Over time it can also be extended into our systems with many more datapoints which are already supported by the driver like undervoltage detection, driver temperature, power cycles, etc...

5.3. DALI 2 + D4i



D4i is an extension of the DALI-2 certification program. D4i LED drivers have a mandatory set of features related to power-supply requirements and smart-data capabilities. Like an SR driver, our sensors are designed to work together with D4i DALI drivers and be energized by the driver.

5.4. SR Drivers



SR (Sensor Ready) drivers, use a standardized DALI interface plus an integrated power supply to energize the sensor, it was developed by Signify before D4i was created as a standard, for the purpose of this guide SR Drivers and D4i drivers can be used interchangeably.

5.5. Architecture options

5.6. Dali Extender (Recommended Choice if available)

The DALI extender can energize an SR sensor and transparently pass on DALI 2 commands to the drivers, it is optically isolated (SELV) which means that any electric issue on the driver side will not affect the sensor and vice versa. The advantage of the DALI extender is that it does not require any firmware to support new functionality, by updating the firmware of the sensor, it can easily support new improvements, fixes and features like tunable white and emergency remote testing.

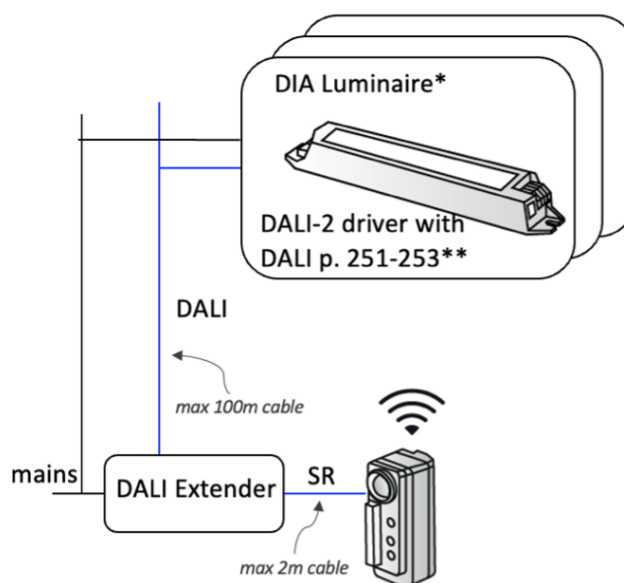

Benefits

Most cost-effective solution.

- Less wiring required, only DALI cabling is needed from the device to the luminaires.
- Transparent failure and energy reports from the drivers.
- Digital service tag supported (only one reported from a single driver at random)
- Maximum 20 drivers supported independently from luminaire power consumption.
- Future proof, no need for firmware updates as it is transparent for the sensors.
- Support for emergency driver with remote testing.
- Support for tunable white.
- CE certified.

Limitations

- 220 to 240 V only, no support for 110 V.
- DALI version 1 not supported.
- Not UL certified.

5.7. SR Bridge DALI (Recommended choice only when DALI extender is not possible)

The SR Bridge DALI needs a mains power connection, it energizes the SR sensor or antenna and translates the DALI messages from the sensor into the DALI port to the drivers, the mains power needs to go through the internal relay of the device to measure the energy consumption and fully switch off the power. A Multi-One interface can be used to configure the SR bridge, but the device cannot be firmware updated.

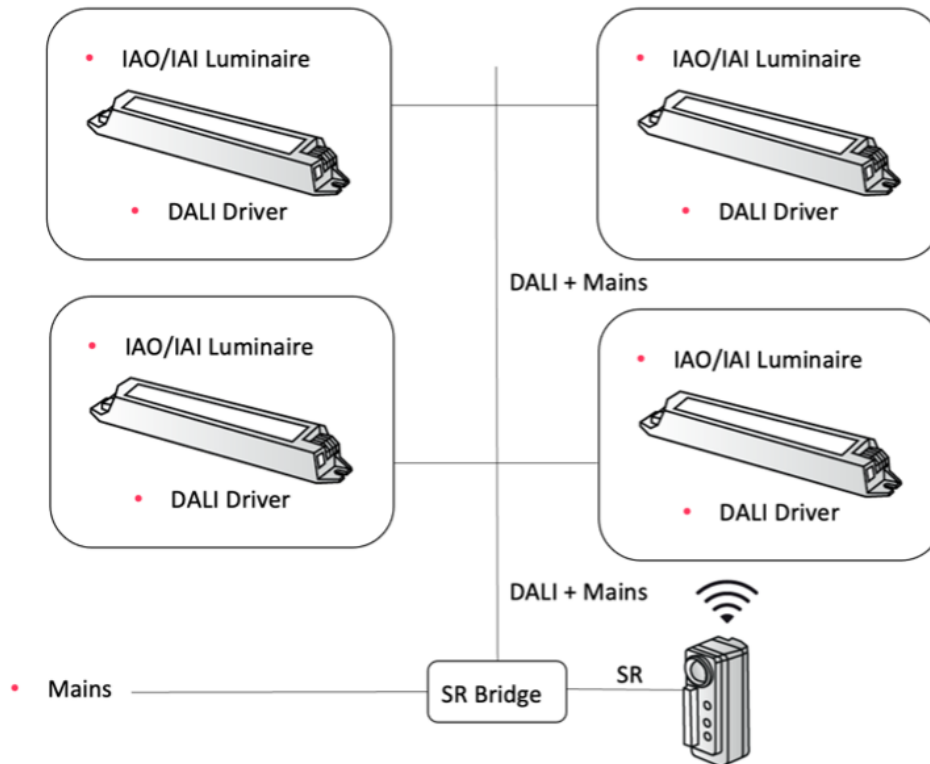

Benefits

- Option to integrate DALI version 1 drivers.
- Configuration options available via Multi-One interface.

Limitations

- Failure reporting has many known issues which may result into incorrect fault reports.
- Wiring requires both DALI and mains power to work properly.
- No support for emergency drivers with remote testing.
- Max 400 VA, for a trunking application using high power luminaires this could mean three to five luminaires only.
- Can not be firmware updated to fix or support new functionality.

5.8. SR Bridge 0-10V

The SR Bridge 0-10V needs a mains power connection, it energizes the SR sensor or antenna and translates the DALI messages from the sensor into the 0-10V port to the drivers, the mains power needs to go through the internal relay of the device to measure the energy consumption and fully switch off the power. A Multi-One interface can be used to configure the SR bridge, but the device cannot be firmware updated.

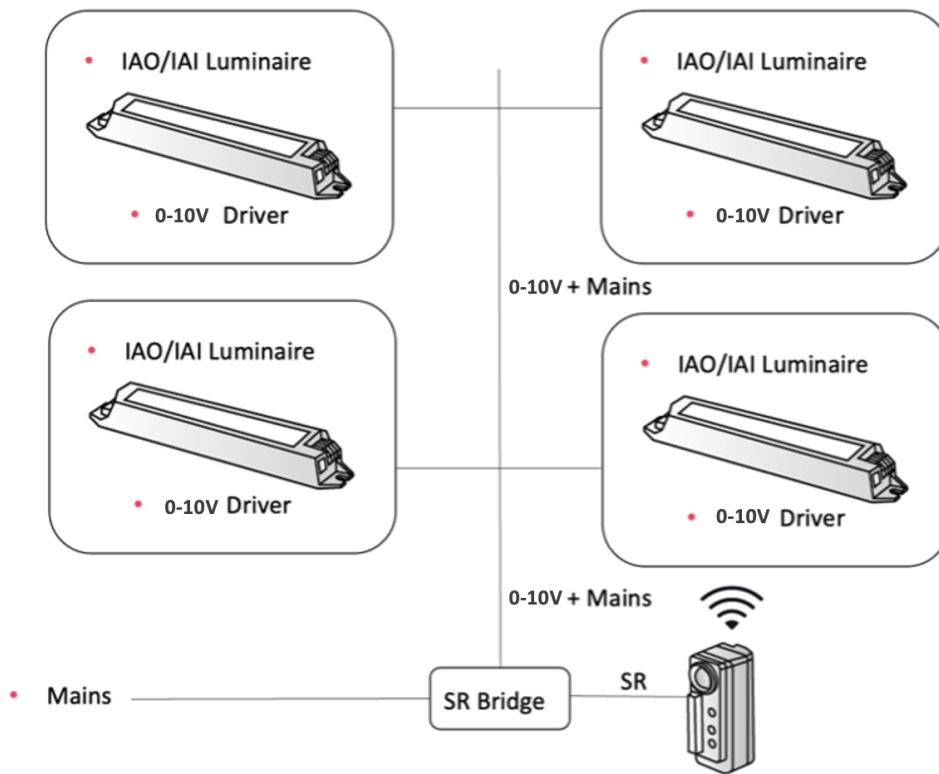

Benefits

- Only option to integrate 0-10V drivers.
- Configuration options available via Multi-One interface.

Limitations

- Failure reporting has many known issues which may result into incorrect fault reports.
- Wiring requires both 0-10V and mains power to work properly.
- No support for emergency drivers with remote testing.
- Max 6.1 A at 120 V, 6.1 A at 208 V, 5.3 A at 240 V, 4.6 A at 277 V, 3.7 A at 347 V.
- Cannot be firmware updated to fix or support new functionality.

5.9. SR drivers or D4i drivers directly connected to the SR sensor or antenna

Multiple SR and D4i drivers can be connected directly to the SR sensor, however a maximum of four active power supplies must be active at a single time, otherwise it can be physically damaging to the sensor. This architecture is possible in some situations where a maximum of four drivers are needed and those drivers have integrated power supplies, in that case there is no need for a DALI extender or SR Bridge.

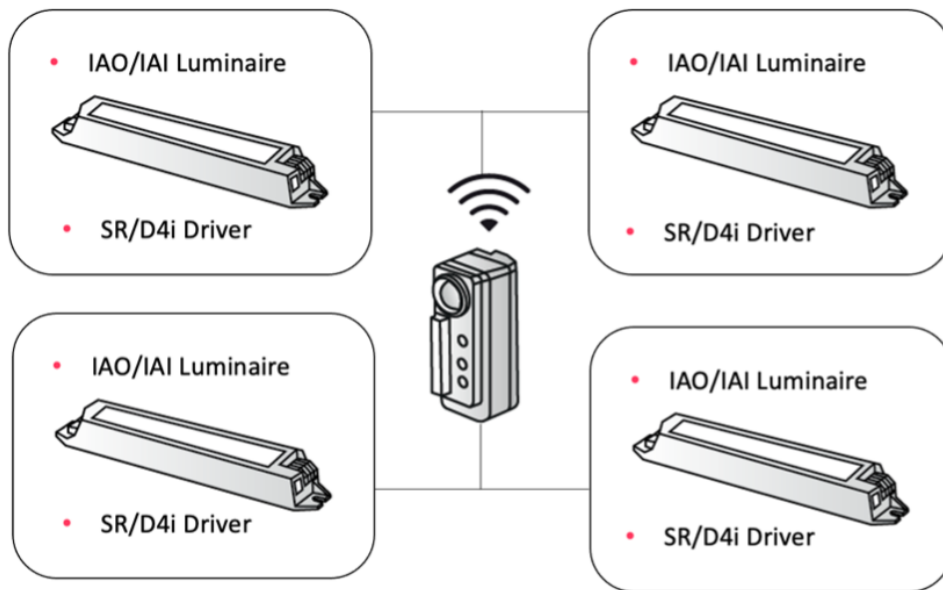

Benefits

- Most cost-effective solution as no extra components are required.
- Less wiring required, only DALI cabling is needed from the sensor to the luminaires.
- Transparent failure and energy reporting from the drivers.
- Digital service tag supported (only one reported from a single driver at random).
- Future proof, no need for firmware updates as it is transparent for the sensors.
- Support for emergency driver with remote testing.
- Support for tunable white.

Limitations

- DALI version 1 not supported.

5.10. Recommendation table for trunking applications

Type/Architecture	DALI Extender	SR Bridge DALI	SR Bridge 0-10V	Direct connection to SR
DALI 1	Not supported	Best choice	Not supported	Not supported
DALI 2	Best choice	Not supported	Not supported	Not supported
DALI 2 + D4i / SR	Best choice (if more than four drivers)	Not supported	Not supported	Best choice (if four or less drivers)
0-10V	Not supported	Not supported	Best choice	Not supported
ON/OFF	Not supported	Best choice	Best choice	Not supported

Learn more about Interact
www.interact-lighting.com

© 2025 Signify Holding. All rights reserved.
Specifications are subject to change without notice. No representation or warranty as to the accuracy or completeness of the information included herein is given and any liability for any action in reliance thereon is disclaimed. All trademarks are owned by Signify Holding or their respective owners.