

PHILIPS

LCN1870

Wireless Gateway



Installation Instructions

Instructions d'installation
Instrucciones de instalación

Istruzioni per l'installazione
Installatie-instructies

Installationsanweisungen
インストール手順

安裝指示书
إرشادات التركيب

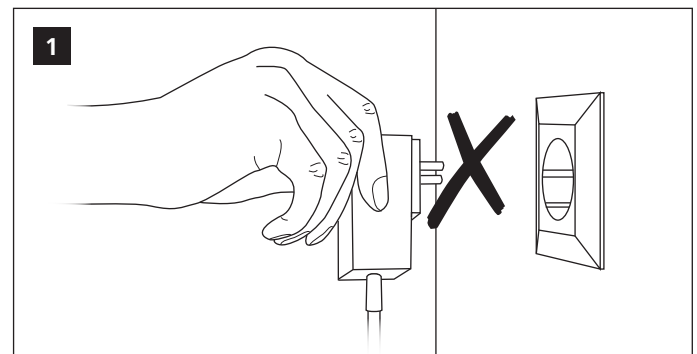
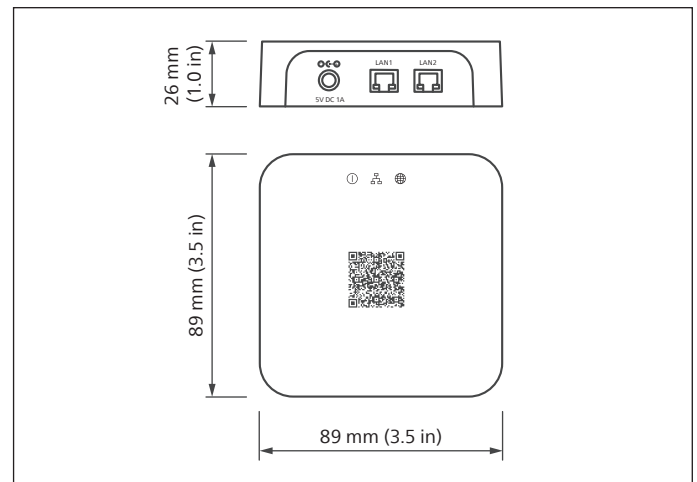
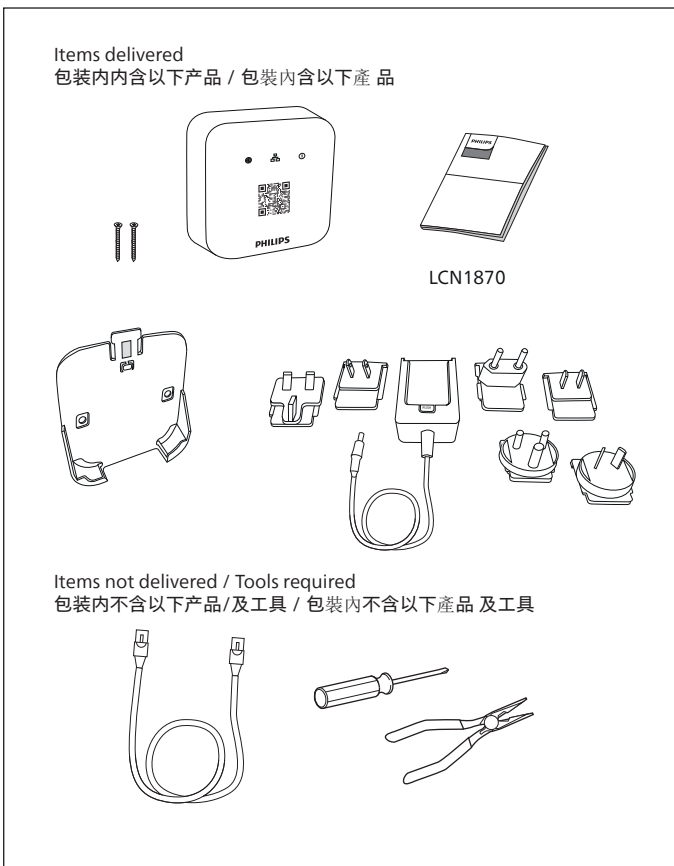

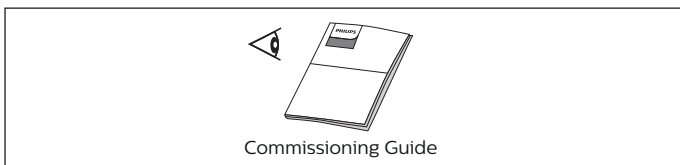
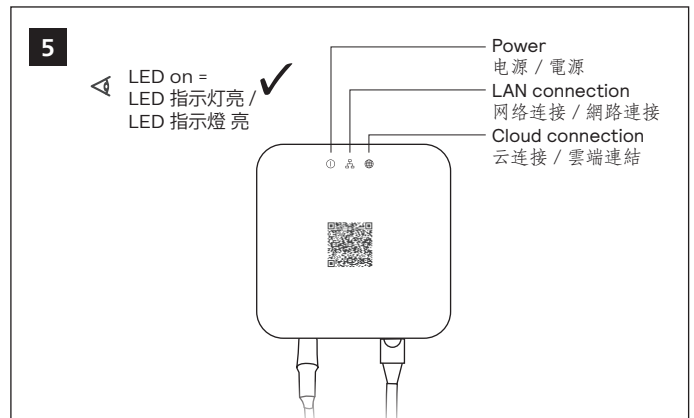
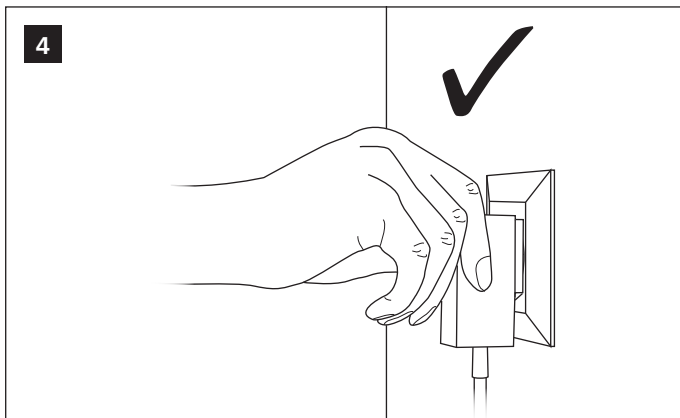
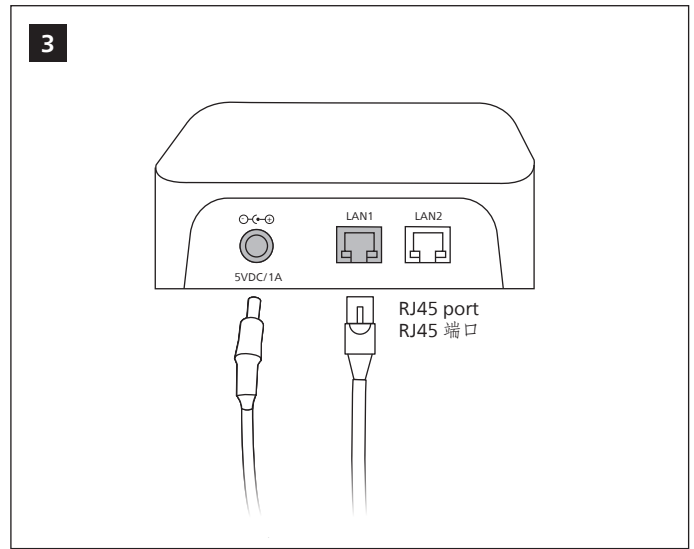
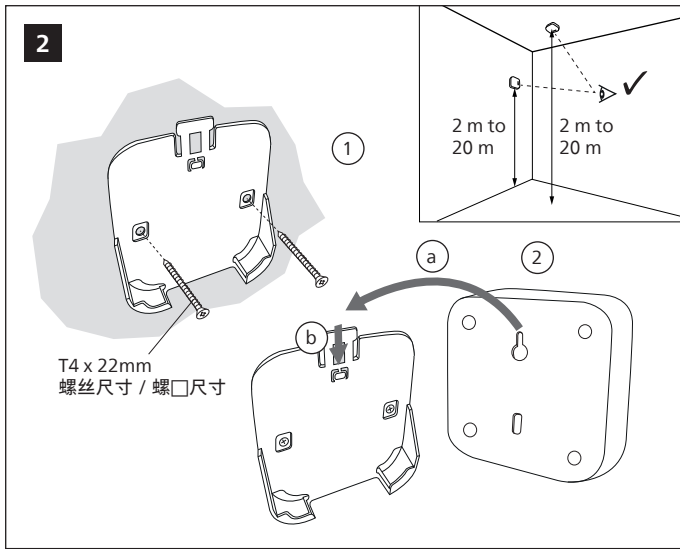

(FR) DÉCLARATION DE CONFORMITÉ À LA FCC/IC
 Ce dispositif est conforme à la partie 15 des règles de la Federal Communications Commission (FCC) des États-Unis et d'Industrie Canada (IC) exempts de licence RSS norme(s). Son fonctionnement est assujéti aux deux conditions suivantes: (1) Ce dispositif ne doit pas provoquer de brouillage préjudiciable, et (2) il doit accepter tout brouillage reçu, y compris le brouillage pouvant entraîner un mauvais fonctionnement. Tous les changements ou modifications non expressément approuvés par Signify, sont susceptibles d'annuler le droit de l'utilisateur à se servir de cet équipement. Ce produit est exclusivement destiné à un usage commercial.

Cet équipement est conforme aux limites d'exposition aux rayonnements IC établies pour un environnement non contrôlé. Cet équipement doit être installé et utilisé avec un minimum de 200 mm de distance entre la source de rayonnement et votre corps.

Notes

- This product contains open source software. The acknowledgements, license texts and the written offer can be retrieved from the product by opening the http page of this product.
- Real time clock function uses a non-replaceable battery.

注意

该产品含有开源软件。相关的声明, 版权等均可通过访问该产品http 网页获得品包含 原件。相的明, 版 等信息替代通 品 http 得

核准编号在产品名牌位置标识
 批准 在 品名牌位置

©2020-2021 Signify Holding. All rights reserved. Specifications are subject to change without notice. No representation or warranty as to the accuracy or completeness of the information included herein is given and any liability for any action in reliance thereon is disclaimed. Philips and the Philips Shield Emblem are registered trademarks of Koninklijke Philips N.V. All other trademarks are owned by Signify Holding or their respective owners.
 4422 947 80353

20 December 2021



(EN) FCC/IC compliance statement
 This device complies with part 15 of the FCC rules for the United States and Industry Canada (IC) license-exempt RSS standard(s). Operation is subject to the following two conditions: (1) This device may not cause harmful interference, and (2) this device must accept any interference received, including interference that may cause undesired operation. Any changes or modifications not expressly approved by Signify could void the user's authority to operate this equipment. This product is intended for commercial use only.

FCC Radiation Exposure Statement

This equipment complies with FCC radiation exposure limits set forth for an uncontrolled environment. This equipment must be installed and operated with a minimum distance 200 mm between the radiator and your body.

IC Radiation Exposure Statement

This equipment complies with IC RSS-102 radiation exposure limits set forth for an uncontrolled environment. This equipment must be installed and operated with a minimum distance 200 mm between the radiator and your body.

FCC statement: This equipment has been tested and found to comply with the limits for a Class A digital device, pursuant to part 15 of the FCC Rules. These limits are designed to provide reasonable protection against harmful interference when the equipment is operated in a commercial environment. This equipment generates, uses, and can radiate radio frequency energy and, if not installed and used in accordance with the instruction manual, may cause harmful interference to radio communications. Operation of this equipment in a residential area is likely to cause harmful interference in which case the user will be required to correct the interference at his own expense.

RF Exposure Information

This device meets the EU requirements (2014/53/EU) on the limitation of exposure of the general public to electromagnetic fields by way of health protection. The device complies with RF specifications when the device used at 321 mm from your body.

Hereby, Signify declares that the radio equipment type LCN1870 is in compliance with Directive 2014/53/EU. The full text of the EU declaration of conformity is available at the following Internet address:
<http://www.philips.com/red>

UK importer address:
 Signify Commercial UK Limited
 3, Guildford Business Park, GU2 8XG

www.philips.com/lighting